

Colossians 3:17

PRODUCT SELECTION



---

The Concrete Advantage.

---

[westerninterlock.com](http://westerninterlock.com)























# Built on a history of service.

From our beginning back in 1990, Western Interlock has been dedicated to providing our customers with a quality product and outstanding service. The journey begins in our production plant, where we have dedicated employees producing and sorting the products; while fine-tuning the process to give you the products that you deserve. Then we store and protect those products from the elements so that when they get to you, they are in good condition, ready to hit the ground and become part of your special project.

The second part of the journey is the people you meet along the way. Western Interlock's brand of customer service is not a department, it's an attitude. We have friendly and knowledgeable sales staff, yard personnel, and delivery drivers, many of whom have been with the company for years. Together we want your experience with us, our product, and your completed project to exceed your expectations.

Throughout our brochure we use a variety of icons and labels to help guide you through the process of choosing the products that are best suited for your project. Use the keys below to learn what each one means:

					<b>Pedestrian Traffic</b>		<b>Not for Heavy Vehicular Traffic</b>		<b>Walls Over 36" Require Engineering</b>
					<b>Light Vehicular Traffic</b>		<b>Suitable for ADA Traffic</b>		<b>Free-standing Garden Wall</b>
<b>SMOOTH</b>	<b>COBBLED</b>	<b>RUSTIC</b>	<b>TEXTURED</b>		<b>Not for Light Vehicular Traffic</b>		<b>OK to Compact Stones</b>		<b>Retaining Wall</b>
					<b>Heavy Vehicular Traffic</b>		<b>Do Not Compact Stones</b>		<b>Glue-together Construction</b>
							<b>Permeable Pavers</b>		

# Table of Contents

## PAVING STONES

Villa Stone	Pages 4-41
Leiden Collection	Page 5
Double Park™	Pages 6-7
Arena Stone	Pages 8-9
Park & Plaza Stone	Page 10
Holland & Half Holland Stones	Page 11
La Lastra™	Pages 12-13
La Pietra™ Moderna	Pages 14-15
City Square	Pages 16-17
Holland Slimline	Page 18
Roma Stone™	Page 19
Cobble Park & Plaza Stone	Pages 20-21
Camino Stone	Pages 22-23
Cobble Rotundo Stone	Pages 24-25
Cobble Slimline	Pages 26-27
Roca Camino	Pages 28-29
Roca Park & Plaza Stone	Pages 30-31
Alpine Stone™	Pages 32-33
Alpine Rotundo Stone™	Pages 34-35
Granite Stone	Pages 36-37
La Pietra™	Pages 38-39
<b>PERMEABLE PAVERS</b>	Pages 40-41
Camino Permeare	Pages 42-46
Holland Permeare	Page 43
Park Permeare	Page 44
VS-5™ Drain Pave & Turf Stone	Page 45
<b>RETAINING WALLS</b>	Page 46
Chateau Wall™	Pages 47-63
Chateau Moderna™	Pages 48-49
Chateau Diviso™	Pages 50-51
Tegula Garden Wall™	Pages 52-53
Nursery™ & Jumbo Nursery Stone™	Pages 54-55
Gradino™ Step Block	Pages 56-57
Versa-Cap™	Page 58
Murata™	Page 59
Murata™ Cappello	Pages 60-61
Monaco Coping	Page 62
<b>FIRE FEATURES</b>	Page 63
Tegula Garden Wall™ 40" Fire Pit	Pages 64-71
Chateau Wall™ 50" Fire Pit	Page 65
Chateau Diviso™ 50" Fire Pit	Page 66
Chateau Moderna™ 50" Fire Pit	Page 67
Deschutes Fireplace Kit	Page 68
Rogue Fireplace Kit	Page 69
Chateau Moderna Fireplace Kits	Page 70



## INSPIRATION GALLERY INSTALLATION GUIDES

Paving Stones	Pages 72-77
Patterns & Borders	Page 78
Chateau Wall™	Pages 79-85
Tegula Garden Wall™	Pages 86-87
Modular Retaining Wall	Page 88
Murata™	Page 89
<b>ACCESSORIES</b>	Pages 90-91
<b>SPECIFICATIONS</b>	Pages 92-93
Standard Finishes & Thicknesses	Pages 94-97
	Page 98





# PAVING STONES

PAVING STONES



Roca Camino Stone Cambridge Blend





Villa Stone Cambridge Blend

# Villa Stone



SMOOTH

This sturdy paver is a vibrant modern classic! The Villa Stone is long and narrow; made in a plank style. It's smooth, beveled surface pairs well with contemporary designs. With a thickness of 100mm the Villa stone is made to stand the weight of traffic and is a uniquely modern option for your landscape.



**Villa Stone**  
443x73x100mm • 17.52x2.87x3.94"

PAVING STONES



Charcoal



Cambridge Blend



Jamestown Blend



Pewter



Leiden Cambridge Blend

PAVING STONES

## Leiden Collection



This family of stones was inspired by art. The Dutch city of Leiden that this collection is named after was where the geometric De Stijl art movement was born. Not surprisingly, the most popular display of the Leiden collection is the geometric five-stone pattern or the random layout. This stone family is a unique favorite!

**PRO TIP:** While the Leiden Collection is available as separate pieces, we've also added a new mold layout that gives you four (4) of the Five Stone pattern modules on each layer. If you're laying this pattern, make it easier and ask for this version.



Cambridge Blend



Jamestown Blend



**Arena**  
298x298x60mm • 11.73x11.73x2.36"



**Plaza**  
298x198x60mm • 11.73x7.80x2.36"



**Park**  
198x198x60mm • 7.80x7.80x2.36"



**Holland**  
198x98x60mm • 7.80x3.86x2.36"



**Half Holland**  
98x98x60mm • 3.86x3.86x2.36"



Leiden Cambridge Blend

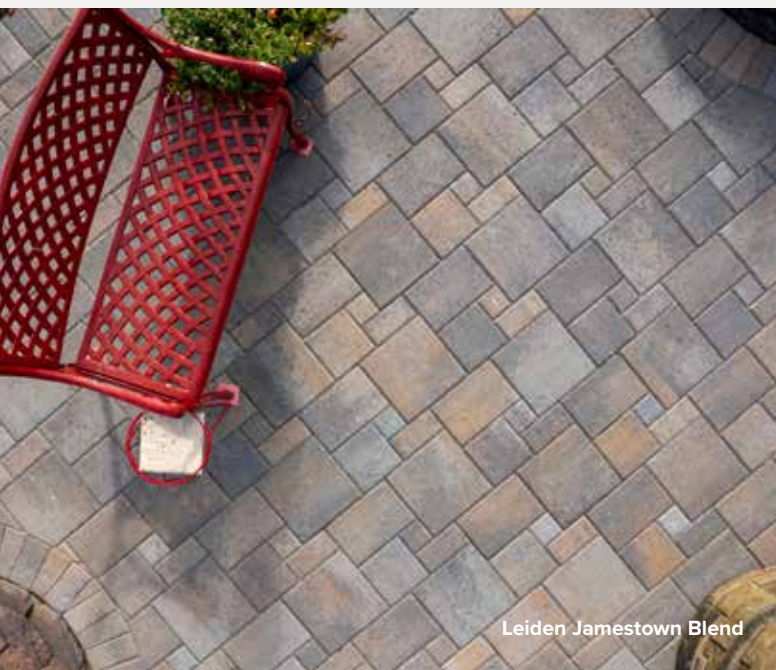

Leiden Jamestown Blend



Leiden Cambridge Blend

PAVING STONES



Leiden Jamestown Blend



Double Park Cambridge Blend

PAVING STONES

# Double Park™



Larger format, modern looking pavers are on trend right now. So to answer market demand, we've taken one of our perennial favorites, Park Stone™, and doubled it. The resulting plank style stone works well by itself in a running bond, or herringbone pattern. It also adds a sixth size to our Leiden Collection for greater versatility. Most amazingly, when combined with our Half Holland Stone, the Double Park makes a beautiful basketweave mosaic pattern. It's orientation in the mold makes for dramatic lengthways color striping for maximum drama.



**Double Park**  
198x396x60mm • 7.80x15.6x2.36"

**DESIGN TIP:** The added length of the Double Park stone makes it an excellent border stone for patios with long straight sides. Because it has fewer joints, it makes for a stronger edge. Plus, it covers a lot of linear feet quickly!



Cambridge Blend



Charcoal



Jamestown Blend



Pewter





Double Park Pewter & Charcoal w/Half Holland Cambridge Blend



PAVING STONES

Double Park Cambridge Blend w/Leiden Cambridge Blend



Double Park Jamestown Blend



Double Park Cambridge Blend



Arena Stone Charcoal w/City Square Pewter

PAVING STONES

# Arena Stone



SMOOTH

Arena Stone has a contemporary smooth, flat top with a beveled edge. Its large 12"x12" size covers a lot of surface area with ease. Arena Stone is part of the Leiden five-stone paver collection that also includes Park, Plaza, Holland and Half Holland stones. It also pairs really well with our 6"x6" City Square (*page 14*) in a 1:2 ratio for a beautiful linen pattern. You can mix and match to create the look you want for enduring appeal.



**Arena Stone**  
298x298x60mm • 11.73x11.73x2.36"



Cambridge Blend



Jamestown Blend



Charcoal/Pewter



Desert Tan



Park & Plaza Stone Cambridge Blend

# Park & Plaza Stone



**SMOOTH**

One of our perennial favorites, Park and Plaza Stone have a flat top with a beveled edge providing a measured contemporary look. With color combinations keyed to styles popular here in the Northwest, Park and Plaza Stone are sure to please. Park and Plaza stone are part of the Leiden five-stone paver collection that also includes Arena, Holland and Half Holland stones. You can mix and match to create the look you want for enduring appeal.



**DESIGN TIP:** Park, Plaza, and Holland are also available in Pewter to allow you to make straight edges with Double Park without cuts.

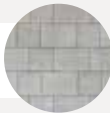

**Park**

198x198x60mm • 7.80x7.80x2.36"



**Plaza**

298x198x60mm • 11.73x7.80x2.36"

PAVING STONES



**Boston Blend**



**Cambridge Blend**



**Jamestown Blend**



**Charcoal • Willamette Blend**



Holland Stone Charcoal & Pewter

PAVING STONES

# Holland & Half Holland Stone



At home both at a Victorian style mansion and a modern flat. Its traditional rectangular brick shape can be used in historical and contemporary applications alike. Holland Stone's striking colors, available surfaces, and modular size allow it to be used in multiple design variations for almost any purpose. Holland and Half Holland Stone are part of the Leiden five-stone paver collection that also includes Arena, Park and Plaza stones.

**DESIGN TIP:** The vivid colors of the solid Holland Stones makes it an excellent accent stone for borders, headers or detail bands. Combine Holland Stone with any of our 60mm stones to add elegance and personality.

**PRO TIP:** Holland Stones are also available in a 80mm thickness, which is suitable for heavy commercial traffic. *(This product is non-stock)*



**Holland**  
198x98x60mm • 7.80x3.86x2.36"



**Half Holland**  
98x98x60mm • 3.86x3.86x2.36"



**Holland & Half Holland Roca Finish**  
*(only stocked in Charcoal)*



**Boston Blend**  
*(not stocked in Half Holland)*



**Cambridge Blend**



**Jamestown Blend**



**Willamette Blend**  
*(not stocked in Half Holland)*



Roca Holland Stone Cambridge Blend *(special order)*



Holland Stone Charcoal

PAVING STONES



Holland Stone Jamestown Blend



**Desert Tan**

*(not stocked in Half Holland)*



**Western Red**

*(not stocked in Half Holland)*



**Charcoal/Pewter**



**Roca Charcoal**

# La Lastra



La Lastra™ Cambridge Blend

PAVING STONES

## La Lastra™



**SMOOTH**

**!** Special installation procedure required.  
See [www.westerninterlock.com/products/la-lastra](http://www.westerninterlock.com/products/la-lastra)

La Lastra™ is a three-piece paving stone family that all module off of a base of 18 and 24 inches. The flat surface, beveled edge and elegant proportions of these generously sized stones are perfect for use in social spaces. La Lastra™ brings unique size and a sleek, modern touch to our growing family of paving stones.



**DESIGN TIP:** For a visually varied layout, try using all three sizes of La Lastra™ laid in a random, irregular layout. To achieve randomness, make sure that four corners never come together. This will result in a layout that is truly random. Rotate each stone 90° to vary the direction of the blend



**DESIGN TIP:** Large pavers can make the most of a small space. With fewer joint lines, larger slabs create an illusion that a space is bigger than it really is.



**Large Square**  
606x606x50mm • 23.86x23.86x1.97"



**Large Rectangle**  
606x453x50mm • 23.86x17.83x1.97"



**Medium Square**  
453x453x50mm • 17.83x17.83x1.97"



**Breitenbush Blend**



**Cambridge Blend**





La Lastra™ Pewter



La Lastra™ Jamestown Blend

PAVING STONES



La Lastra™ Cambridge Blend



Jamestown Blend



Desert Tan



Pewter



Charcoal

La Pietra  
MODERNA

NOW AVAILABLE  
INDIVIDUALLY

La Pietra Moderna Cambridge Blend

# La Pietra™ Moderna



**SMOOTH**



Special installation procedure required.  
See [www.westerninterlock.com/products/la-pietra-moderna/](http://www.westerninterlock.com/products/la-pietra-moderna/)

La Pietra™ Moderna's smooth finish pairs well with our other smooth stones such as Holland or our Leiden collection. Like these other stones, La Pietra™ Moderna also has a bevel on the edge, but we've made it slightly wider to balance it with the larger size.



**DESIGN TIP:** La Pietra™ Moderna is now available individually which opens up a whole bunch more pattern options for this stone (see page 79).



Cambridge Blend



Jamestown Blend



**Grande**

530x530x60mm • 20.87x20.87x2.36"



**Large Rectangle**

530x352x60mm • 20.87x13.86x2.36"



**Medium Square**

352x352x60mm • 13.86x13.86x2.36"



**Small Rec**

352x174x60mm • 13.86x6.85x2.36"



**Small Square**

174x174x60mm • 6.85x6.85x2.36"



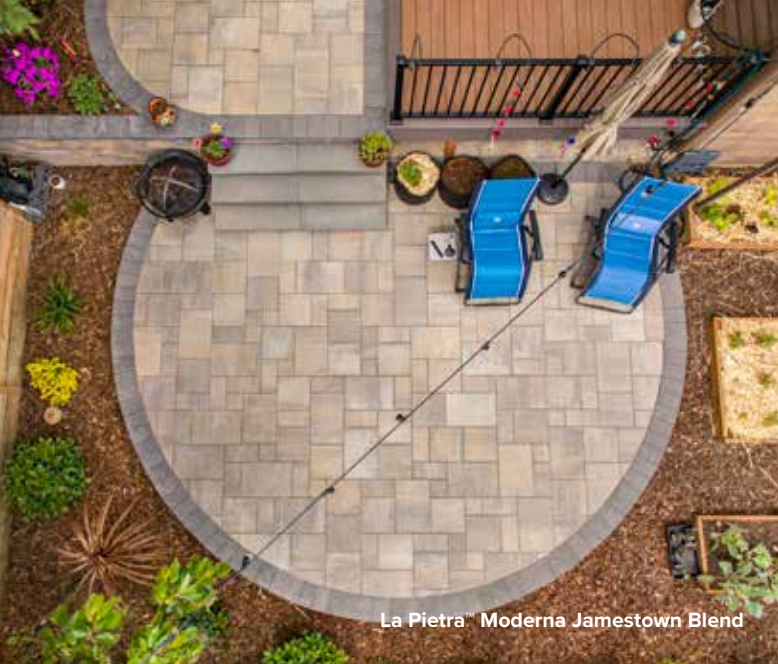

La Pietra™ Moderna Jamestown Blend



PAVING STONES

La Pietra™ Moderna Cambridge Blend



La Pietra™ Moderna Cambridge Blend



Umbria Blend



La Pietra™ Moderna Umbria Blend



City Square Pewter

# City Square



SMOOTH

This modern paver feels just like downtown. Petula Clark said that the lights are brighter downtown, and City Square is a paver that is right at home there. It is medium in size and contemporary in style with a flat, smooth top. The City Square makes an excellent border stone, and also pairs nicely with our Arena Stone in a 1:2 ratio.



City Square

149x149x60mm • 5.87x5.87x2.36"



Charcoal



Desert Tan

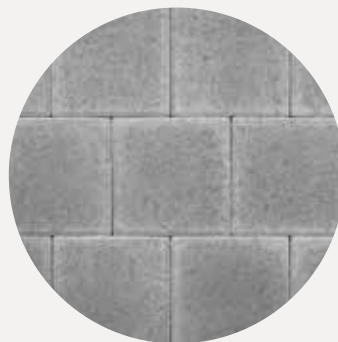

Pewter



Holland Slimline Boston Blend

# Holland Slimline

 **SMOOTH**

The versatile shape of Holland is now available in a slimline profile. It is a great value alternative, as an option for overlays where height is a concern, or for use in pedestrian areas that will never see vehicular traffic. Holland Slimline also makes an excellent border for our Cobble Slimline.



**Holland Slimline**  
198x98x40mm • 7.80x3.86x1.57"

PAVING STONES



**WARNING:** Slimline stones are intended to be used for pedestrian traffic ONLY.



**Boston Blend**



**Charcoal**



**Jamestown Blend**



**Pewter**



Roma Stone Cambridge Blend

PAVING STONES

# Roma Stone™



**COBBLED** **TEXTURED**

Our new Roma Stone™ blends timeless aesthetics with robust performance. With its organic shapes, Roma Stone™ gives pathways, patios, and driveways a very special, natural charm while allowing rainwater to pass through. Each layer contains 12 distinct shapes and sizes in varying quantities for maximum creative options.



Roma Stone™  
Various Sizes x 60mm



**NOTICE:** This product sold by the layer only. Take this into consideration when ordering materials.



**DESIGN TIP:** Lay it right side up for a true cobblestone look, or lay it upside down for a more contemporary look. Roma Stone™ can also be tumbled for a roca finish.



**PRO TIP:** We recommend installing Roma Stone™ with SEK X-treme Wide Joint, EasyJoint, or 1/4"-10 gravel.



Cambridge Blend



Charcoal



Jamestown Blend



Pewter



Roma Stone™ Charcoal



Roma Stone™ Pewter (laid upsidedown)

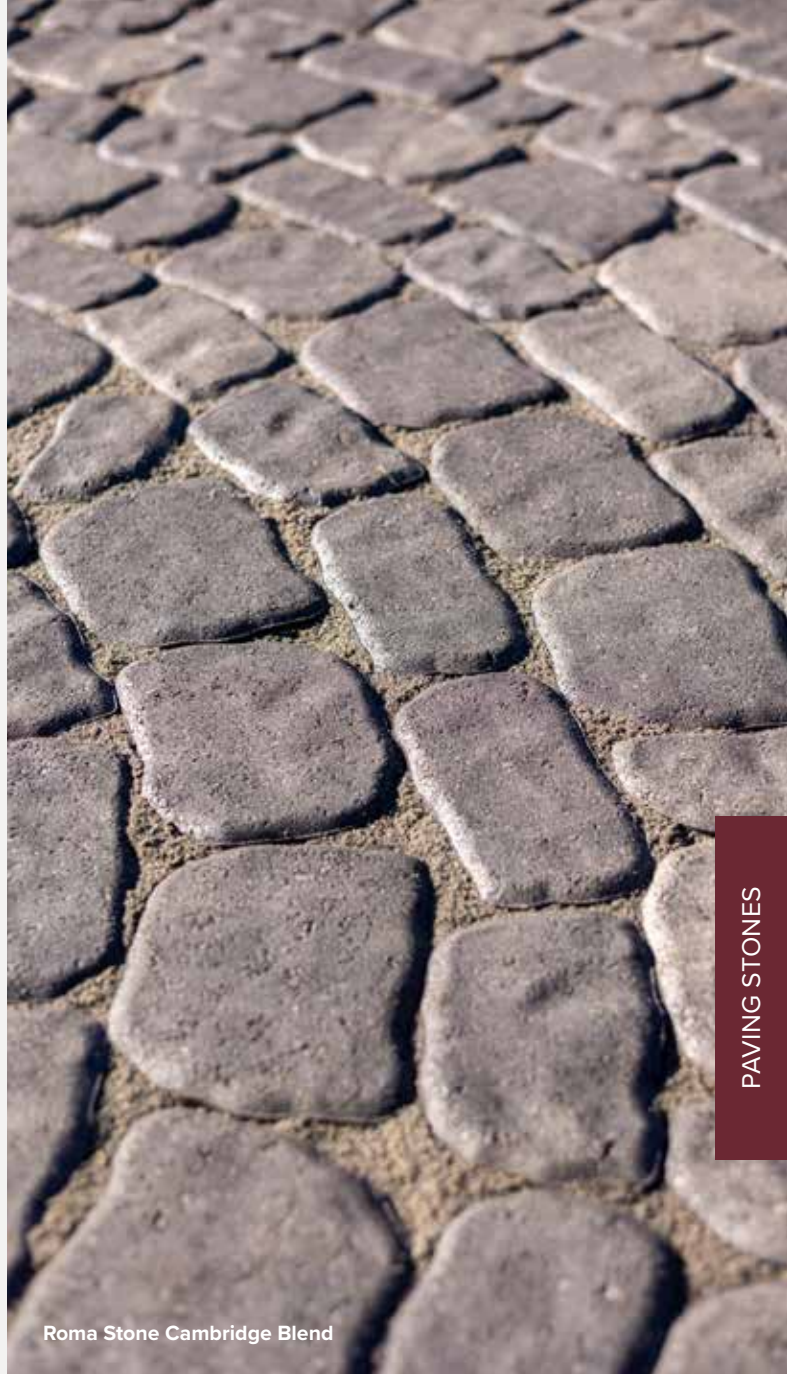

Roma Stone Cambridge Blend

PAVING STONES



Roma Stone Jamestown Blend



Cobble Park & Plaza Cambridge Blend

PAVING STONES

# Cobble Park & Plaza Stone



**COBBLED**

Cobble Park and Plaza Stone have rounded edges with a flat top, giving them the look of a vintage European cobblestone street and a softer worn look than the tumbled Roca. They are available in a broad variety of colors and are part of a paver system that includes Cobble Park, Cobble Plaza, and Cobble Rotundo Stones. Using Cobble Park and Plaza, you can create a look with enduring appeal.



**Cobble Park**  
198x198x60mm • 7.80x7.80x2.36"



**Cobble Plaza**  
298x198x60mm • 11.73x7.80x2.36"



**Cambridge Blend**



**Charcoal**



**Charleston Blend**



**Columbia Blend**



Cobble Park & Plaza Cambridge Blend



PAVING STONES

Cobble Park & Plaza Stone Columbia Blend



Cobble Park & Plaza Jamestown Blend



Jamestown Blend



Pewter



Cobble Park & Plaza Cambridge Blend



Camino Stone Cambridge Blend

# Camino Stone



**COBBLED**

Camino Stone is available in three sizes, with a traditional cobble finish and many color choices that give this stone an exciting array of possibilities. Its old-world charm and vivid pattern combinations lend themselves well to beautiful project designs, making it one of our most popular stones.



**DESIGN TIP:** The Camino Stone Small Rec can be laid by itself as a great cobbled alternative to our Holland Stone. It also makes an interesting three stone pattern when laid with the other Camino Stones, as well as a complementary single, double or triple border.



**Large Rec**  
238x158x60mm • 9.37x6.22x2.36"



**Square**  
158x158x60mm • 6.22x6.22x2.36"



**Small Rec**  
158x118x60mm • 6.22x4.65x2.36"



**Boston Blend**



**Britewood Blend**



**Cambridge Blend**



**Charcoal/Pewter**





Camino Stone Jamestown Blend



Camino Stone Columbia Blend

PAVING STONES



Camino Stone Boston Blend



Columbia Blend



Jamestown Blend



Umbria Blend



Willamette Blend



Cobble Rotundo Stone Jamestown Blend

# Cobble Rotundo Stone



Cobble Rotundo Stone is a circle system that works as either a beautiful stand-alone circular patio or an intriguing inlaid pattern with other pavers. Cobble Rotundo Stone has an intriguing, slightly rippled cobblestone surface and comes in a variety of colors. Imagine all of the creative ways that this striking paver can be added to your landscape, whether it's a complete circle, curved steps or inlaid fans.

**NOTICE:** This product sold by the layer only. Take this into consideration when ordering materials.

**DESIGN TIP:** Cobble Rotundo Stone is also available in a tumbled Roca finish. This is a non-stock, special order item and fees will apply.



Britewood Blend



Cambridge Blend



X-Small



Center



Small



Medium



Large



Rectangle

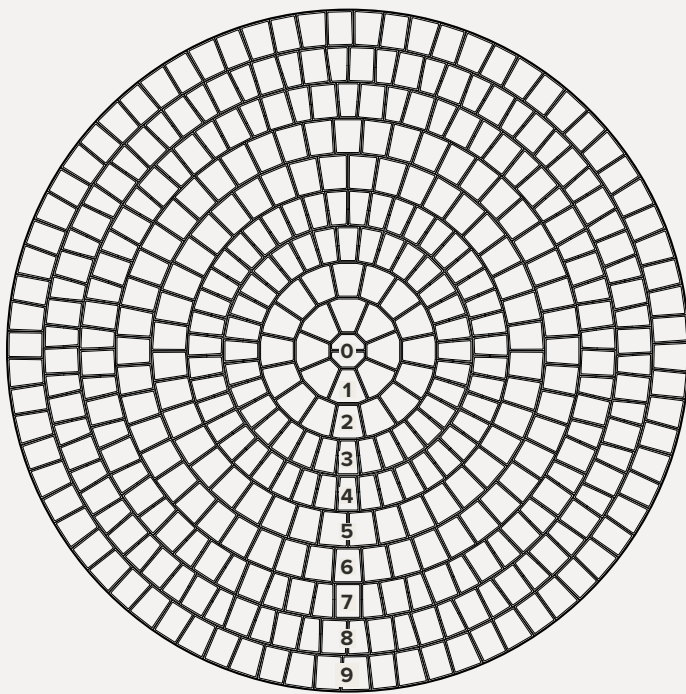

### 12 LAYER CIRCLE KIT

<b>Diameter</b>	3.8m (12.5')
<b>Area</b>	11.34m <sup>2</sup> (122.67 ft <sup>2</sup> )
<b>Circumference</b>	11.93m (39.14')
<b>Height</b>	60mm (2.36')

### LAYOUT OF LAYERS ON PALLET

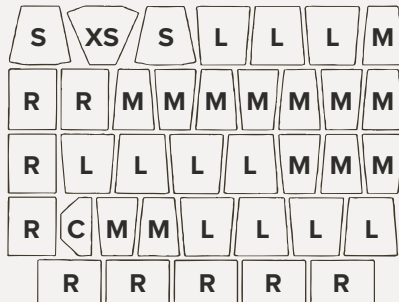

1 Layer = 1 Center, 1 X-Small, 2 Small, 13 Medium, 11 Large, 9 Rectangle

### NUMBER OF STONES NEEDED TO COMPLETE CIRCLE ROWS

Row	Stones Required	Diameter
<b>Circle Row 0:</b>	2 Center Stones	8" Diameter <sup>1</sup>
<b>Circle Row 1:</b>	8 X-Small Stones	23 5/8" (1.97') Diameter <sup>2</sup>
<b>Circle Row 2:</b>	16 Small Stones	39 3/8" (3.28') Diameter <sup>2</sup>
<b>Circle Row 3:</b>	32 Medium Stones	55 1/8" (4.59') Diameter <sup>2</sup>
<b>Circle Row 4:</b>	43 Medium Stones	70 7/8" (5.91') Diameter <sup>2</sup>
<b>Circle Row 5:</b>	40 Large Stones	86 5/8" (7.22') Diameter <sup>2</sup>
<b>Circle Row 6:</b>	48 Large Stones	102 3/8" (8.53') Diameter <sup>2</sup>
<b>Circle Row 7:</b>	33 Medium & 33 Rectangle	118 1/8" (9.84') Diameter <sup>3</sup>
<b>Circle Row 8:</b>	38 Medium & 38 Rectangle	133 7/8" (11.16') Diameter <sup>4</sup>
<b>Circle Row 9:</b>	37 Large & 37 Rectangle	149 5/8" (12.47') Diameter <sup>4</sup>

<sup>1</sup> Requires 2 layers on pallet

<sup>2</sup> Requires 8 layers on pallet

<sup>3</sup> Requires 9 layers on pallet

<sup>4</sup> Requires 12 layers on pallet

PAVING STONES



Charleston Blend



Columbia Blend



Jamestown Blend



Willamette Blend



Cobble Slimline Jamestown Blend

PAVING STONES

# Cobble Slimline



Cobble Slimline has a traditional soft-edged, old-world look. Its thinner profile is a great solution for overlays where height is a concern, or for areas which will never receive vehicular traffic. Cobble Slimline is an economical alternative to our regular paver line. Its two available sizes give it a myriad of pattern options.



**Large Rec**  
208x138x40mm • 8.19x5.43x1.57"



**Square**  
138x138x40mm • 5.43x5.43x1.57"

**!** **WARNING:** Slimline stones are intended to be used for pedestrian traffic ONLY.



**Charcoal** (*Large Rec only*)



**Cambridge Blend**



**Columbia Blend**



**Jamestown Blend**



Cobble Slimline Jamestown Blend



Cobble Slimline Jamestown Blend



Cobble Slimline Columbia Blend

PAVING STONES



Cobble Slimline Jamestown Blend



Roca Camino Stone Cambridge Blend

PAVING STONES

# Roca Camino Stone



**RUSTIC**

Roca Camino Stone offers a unique surface treatment produced by individually tumbling the stones. The broken edge and ruggedly elegant profile of Roca Camino Stone are available in an array of colors. Available in three sizes, and capable of multiple pattern combinations, this stone is filled with old-world charm that lends itself well to beautiful designs.



**PRO TIP:** Roca stones are intended to be installed as shipped on the pallet. To ensure the desired look, do not turn the stones over when laying them.



**Large Rec**  
238x158x60mm • 9.37x6.22x2.36"



**Square**  
158x158x60mm • 6.22x6.22x2.36"



**Small Rec**  
158x118x60mm • 6.22x4.65x2.36"



**Cambridge Blend**



**Charcoal**  
(only stocked in Large Rec)



**Columbia Blend**



**Jamestown Blend**



Roca Camino Stone Columbia Blend



PAVING STONES

Roca Camino Stone Cambridge Blend



Roca Camino Stone Jamestown Blend



Roca Camino Stone custom mix of Jamestown and Columbia Blends



Roca Park, Plaza & Holland Stone Jamestown Blend

# Roca Park & Roca Plaza Stone



**RUSTIC**

Roca Park and Roca Plaza Stone offer a unique surface treatment produced by individually tumbling the stones. Both shapes have a broken edge with ruggedly appealing looks and are available in an array of colors. By combining Roca Park and Roca Plaza with Roca Holland and Roca Half Holland stones, you can lay custom four stone blends to create interesting and unique designs.



**PRO TIP:** Roca stones are intended to be installed as shipped on the pallet. To ensure the desired look, do not turn the stones over when laying them.



**Roca Park**  
198x198x60mm • 7.80x7.80x2.36"



**Roca Plaza**  
298x198x60mm • 11.73x7.80x2.36"



**Cambridge Blend**



**Columbia Blend**



**Jamestown Blend**





Roca Park & Plaza Stone Jamestown Blend



Roca Park & Plaza Cambridge Blend



Roca Park & Plaza Stone Columbia Blend

PAVING STONES



Roca Park & Plaza Jamestown Blend



Alpine Stone™ Jamestown Blend

PAVING STONES

# Alpine Stone™



RUSTIC

TEXTURED

Bring the majestic feel of the mountains to your own backyard. Alpine Stone™ features a hand-carved surface and a rustic finish with broken edges. At 70mm thick, it is durable and works really well for driveways. It comes in four sizes and two different colors, and nicely complements both our Tegula Garden Wall and our Chateau Garden Wall.



**PRO TIP:** To prevent surface damage when compacting textured stones, use a protective pad between the plate compactor and the paving stones.



**DESIGN TIP:** Alpine Stone™ can be laid with the textured face down to become a thicker version of our roca pavers that is suitable for vehicular traffic. The four sizes along with the available circle system give you the option of a wider range of roca paver sizes.



**Columbia Blend**

Shown in tumbled finish



**Jamestown Blend**

Shown in non-tumbled finish

Both colors available in either tumbled or non-tumbled finishes



**Large Square**

328x328x70mm • 12.91x12.91x2.76"



**Large Rec**

328x218x70mm • 12.91x8.58x2.76"



**Medium Square**

218x218x70mm • 8.58x8.58x2.76"



**Small Rec**

218x108x70mm • 8.58x4.25x2.76"

(Small Rec also stocked in Charcoal)

Western Interlock products are made from natural materials and due to variables in the photographic reproduction process, the actual color of the products may vary slightly. For a truly accurate representation, we invite you to stop by any of our retail facilities to see them in person.



Alpine Stone™ Columbia Blend



PAVING STONES

Alpine Stone™ Jamestown Blend (non-tumbled)



Alpine Stone™ Jamestown Blend (non-tumbled)



Alpine Stone™ Jamestown Blend



Alpine Rotundo Stone™ Jamestown Blend Standard

PAVING STONES

# Alpine Rotundo Stone™



RUSTIC

TEXTURED

Alpine Rotundo Stone™ is a rugged circle system that works either as a beautiful stand-alone circular patio or as an intriguing inlaid pattern with Alpine Stone™. Available in standard two colors, Alpine Rotundo Stone™ complements the weathered look of any of our tumbled pavers or wall blocks.



**NOTICE:** This product sold by the layer only. Take this into consideration when ordering materials.



**PRO TIP:** To prevent surface damage when compacting textured stones, use a protective pad between the plate compactor and the paving stones.



**DESIGN TIP:** Alpine Stone™ can be laid with the textured face down to become a thicker version of our roca pavers that is suitable for vehicular traffic. The four sizes along with the available circle system give you the option of a wider range of roca paver sizes.



Columbia Blend



Jamestown Blend

Both colors available in either tumbled or non-tumbled finishes



Single Stone

332x310x236x70mm • 13.07x12.20x9.29x2.75"



Small

332x310x200x70mm • 13.07x12.20x7.87x2.75"



X-Small

360x320x150x70mm • 14.17x12.60x5.91x2.75"



Center

235x170x170x70mm • 9.25x6.69x6.69x2.75"

Western Interlock products are made from natural materials and due to variables in the photographic reproduction process, the actual color of the products may vary slightly. For a truly accurate representation, we invite you to stop by any of our retail facilities to see them in person.

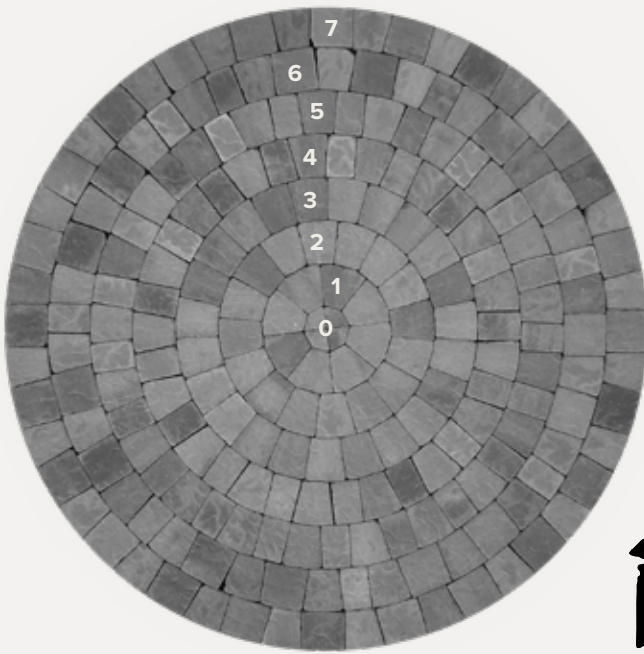

**Large Square**  
328x328x70mm • 12.91x12.91x2.76"



**Large Rec**  
328x218x70mm • 12.91x8.58x2.76"

To complete a circle larger than 11.91', it is necessary to utilize part of the regular Alpine Stone™ family.



**LAYOUT OF LAYERS ON PALLET**

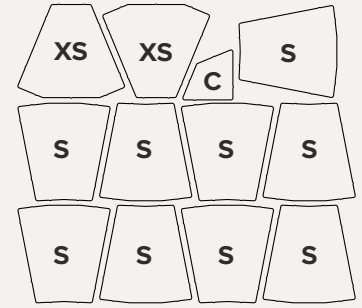

1 Layer = 1 Center, 2 X-Small, 9 Small

**ALPINE ROTUNDO SPECS**

Circle Row	Diameters
Circle Row 0	13" Dia.
Circle Row 1	39" (3.4') Dia.
Circle Row 2	65" (5.41') Dia.
Circle Row 3	91" (7.58') Dia.
Circle Row 4	117" (9.75') Dia.
Circle Row 5	143" (11.91') Dia.
Circle Row 6	169" (14.08') Dia.
Circle Row 7	195" (16.4') Dia.
Height	70mm (2.75 in.)

**NUMBER OF STONES NEEDED TO COMPLETE CIRCLE ROWS**

Stone Sizes	Row 0 <sup>a</sup>	Row 1 <sup>a</sup>	Row 2 <sup>a</sup>	Row 3 <sup>b</sup>	Row 4 <sup>b</sup>	Row 5 <sup>b</sup>	Row 6 <sup>b</sup>	Row 7 <sup>b</sup>
Center <sup>c</sup>	4							
X-Small <sup>c</sup>		8						
Small <sup>c</sup>			16	17				
Single Stone				23	21	22	24	
Large Rec					17	21	8	
Large Square							14	24
<b>Total Stones Needed</b>	<b>4</b>	<b>8</b>	<b>16</b>	<b>23</b>	<b>34</b>	<b>42</b>	<b>44</b>	<b>48</b>

<sup>a</sup> Requires 4 layers on pallet

<sup>b</sup> Requires 4 layers on pallet plus additional stones

<sup>c</sup> These stones are not available individually





Granite Stone Jamestown Blend

PAVING STONES

# Granite Stone



**TEXTURED**

With our Granite Stone pavers, our goal is to bring a rugged granite look to the comfort of your own backyard. In order to transfer the fine texture of the granite on to the paving stone, we digitized a piece of actual stone, copying its surface exactly. The resulting fine surface texture closely resembles the original stone but is less aggressive than our other textured stones, Alpine Stone™ and La Pietra™. Get the natural stone look you love, but in a uniform size and shape for easy laying.



**PRO TIP:** The fine detail on the surface of the stone is very susceptible to damage from compactors. To eliminate the possibility of surface damage, do not compact Granite Stone without the use of a protective pad.



**Cambridge Blend**



**Charcoal**

(not available in Granite Arena Stone)



**Granite Arena**

298x298x60mm • 11.73x11.73x2.36"



**Granite Plaza**

298x198x60mm • 11.73x7.80x2.36"



**Granite Park**

198x198x60mm • 7.80x7.80x2.36"



**Granite Holland**

198x98x60mm • 7.80x3.86x2.36"



**Granite Half Holland**

98x98x60mm • 3.86x3.86x2.36"



Granite Stone Cambridge Blend



PAVING STONES

Granite Stone Cambridge Blend



Granite Stone Jamestown Blend



Columbia Blend



Jamestown Blend



Granite Stone Jamestown Blend  
39

# La Pietra

NOW AVAILABLE  
INDIVIDUALLY

La Pietra™ Jamestown Blend

PAVING STONES

## La Pietra™



**TEXTURED**



Special installation procedure required.  
See [www.westerninterlock.com/products/la-pietra-quattro](http://www.westerninterlock.com/products/la-pietra-quattro)

La Pietra™ is naturally elegant and eye-catching! The textured surface treatment and generally larger sizes of La Pietra™ replicate the look of natural slab Pennsylvania bluestone. This family of slabs consists of five basic sizes that all module off of a base of 7, 14 and 21 inches. The unique size and texture of La Pietra™ is another exciting option in our growing family of paving stones.



**DESIGN TIP:** La Pietra™ is now available individually which opens up a whole bunch more pattern options for this stone (see page 79).



Breitenbush Blend



Cambridge Blend



**Grande**

530x530x60mm • 20.87x20.87x2.36"



**Large Rectangle**

530x352x60mm • 20.87x13.86x2.36"



**Medium Square**

352x352x60mm • 13.86x13.86x2.36"



**Small Rec**

352x174x60mm • 13.86x6.85x2.36"



**Small Square**

174x174x60mm • 6.85x6.85x2.36"





La Pietra™ Breitenbush Blend



La Pietra™ Columbia Blend



La Pietra™ Cambridge Blend

PAVING STONES



Columbia Blend



Jamestown Blend



Umbria Blend



Park Permeare & Holland Permeare Columbia Blend

PERMEABLE PAVERS

# PERMEABLE PAVERS

Permeable pavers come in all shapes and sizes. Currently, we have five permeable paving stone options, and while they're available in a myriad of textures, and colors, each is designed to allow water to permeate directly into the ground.

There is a misconception that permeable pavers work by allowing water through the paver itself. This is not true. The water goes in through wide, specially-prepared joints. All of our pavers are very dense, which prevents water from entering the stone itself. Additionally, instead of packing a multi-layered sand and gravel base as you would when installing standard pavers, you lay down layers of various sized open-graded rock so water will drain through the pavers and into the soil. For more information, visit [www.westerninterlock.com/what-are-permeable-pavers](http://www.westerninterlock.com/what-are-permeable-pavers)



**PERMEABLE:** Look for this logo to choose a Permeable Paver for your next job.





Camino Permeare Jamestown Blend

# Camino Permeare



**Special installation procedure required.**  
 See [www.westerninterlock.com/products/camino-permeare](http://www.westerninterlock.com/products/camino-permeare)

Camino Permeare combines a unique look that resembles the look of old European city streets, but with water permeable joints. It is visually similar to our popular Camino Stone family that also includes the standard Camino Stone as well as the Roca Camino Stone. Camino Permeare is 6.25% open on average.

**DESIGN TIP:** Camino Permeare can be used as a visually similar drainage option with our standard Camino Stones. They will *not* directly interface with standard Camino Stones.

**PRO TIP:** Permeable Pavers require a properly installed base for them to work correctly.



**Camino Permeare Large Rec**  
 238x158x60mm • 9.37x6.22x2.36"  
 (5.8% open)



**Camino Permeare Square**  
 158x158x60mm • 6.22x6.22x2.36"  
 (6.7% open)



Cambridge Blend



Columbia Blend



Jamestown Blend

PERMEABLE PAVERS



Holland Permeare Pewter

PERMEABLE PAVERS

# Holland Permeare



**SMOOTH**

**Special installation procedure required.**  
 See [www.westerninterlock.com/products/holland-permeare](http://www.westerninterlock.com/products/holland-permeare)

Holland Permeare is a permeable twist on a versatile classic. Its traditional rectangular brick shape can be used in historical and contemporary applications alike. Holland Permeare's modular size allows it to be used directly with our Park Permeare.



**Holland Permeare**  
 198x98x60mm • 7.80x3.86x2.36"  
 (8.7% open)

 **DESIGN TIP:** Holland Permeare and Park Permeare can be used as a visually similar drainage option with our standard Park, Plaza and Holland stones. They will *not* directly interface with standard Park, Plaza and Holland stones.

 **PRO TIP:** Permeable Pavers require a properly installed base for them to work correctly.

 **PRO TIP:** Holland Permeare is also available in a non-stock commercial grade 80mm thickness. Each layer is prearranged in the Herringbone pattern for easy machine laying.



Columbia Blend



Jamestown Blend



Pewter





Park Permeare & Holland Permeare Columbia Blend

# Park Permeare



**SMOOTH**



Special installation procedure required.  
See [www.westerninterlock.com/products/park-permeare](http://www.westerninterlock.com/products/park-permeare)

Just like our standard Park Stones, Park Permeare has a flat top with a beveled edge providing a measured contemporary look. Park Permeare's modular size allows it to be used directly with our Holland Permeare.



**Park Permeare**  
198x198x60mm • 7.80x7.80x2.36"  
(5.9% open)



**DESIGN TIP:** Holland Permeare and Park Permeare can be used as a visually similar drainage option with our standard Park, Plaza and Holland stones. They will *not* directly interface with standard Park, Plaza and Holland stones.



**PRO TIP:** Permeable Pavers require a properly installed base for them to work correctly.



Columbia Blend



Jamestown Blend

# VS-5™ Drain Pave



**!** Special installation procedure required.  
[www.westerninterlock.com/products/vs-5-drain-pave](http://www.westerninterlock.com/products/vs-5-drain-pave)

VS-5™ Drain Pave offers a solid surface that is similar to a standard paving stone, while still maintaining an extremely high level of water drainage. Designed for vehicular traffic, it has a series of anti-shift grooves on the bottom of each stone. VS-5™ Drain Pave works well with 80mm Park and Holland Stones.



**PRO TIP:** Permeable Pavers require a properly installed base for them to work correctly.



**VS-5™ Drain Pave**  
198x198x88mm • 7.80x7.80x3.46"  
(10% open)

PERMEABLE PAVERS



# Turf Stone



Preserving green space, reducing storm run-off and erosion control are the primary uses for Turf Stone. The stone is designed to provide 60% concrete surface with 40% open area. The open spaces, when filled, allow ample space for planting grass or similar ground cover. Turf Stone is perfect for the natural look of lawn with the hard wearing qualities of concrete.



**Turf Stone**  
600x400x100mm • 23.62x15.75x3.94"  
(40% open)



**PRO TIP:** Turf Stone is designed to be laid with the scored side facing up.





Murata™ Cambridge Blend

---

## RETAINING WALLS



Tegula Garden Wall™ Columbia Blend

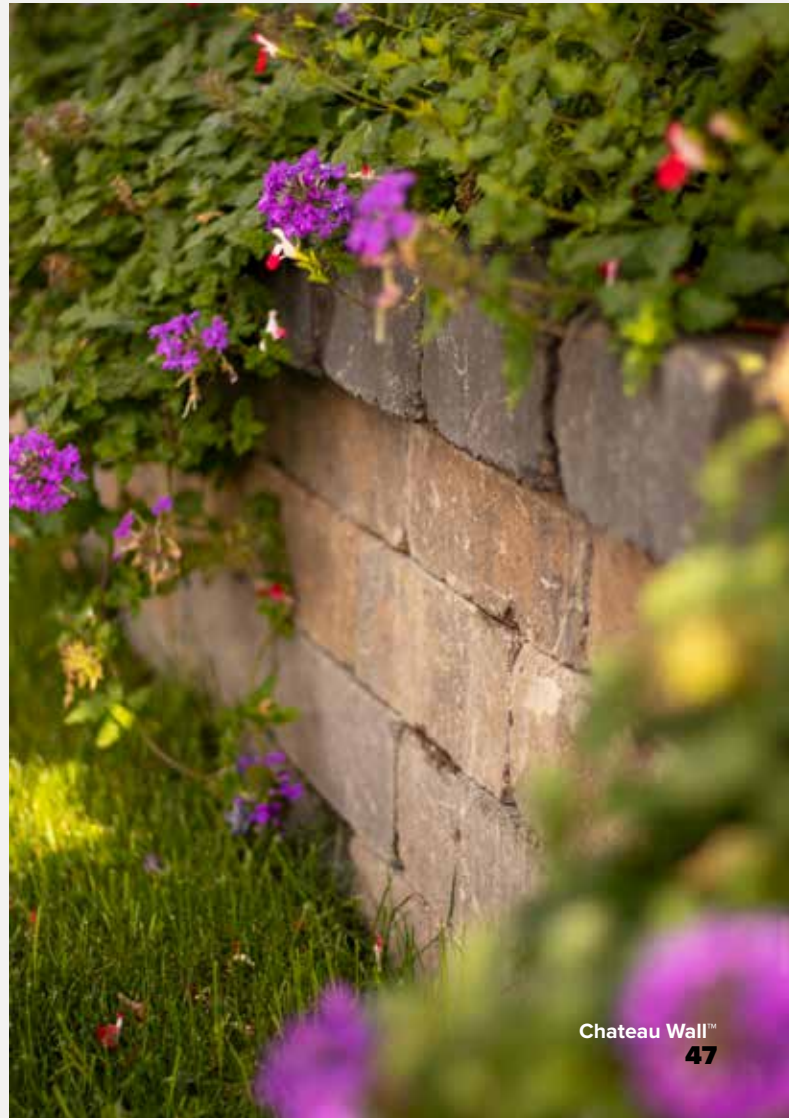

Chateau Wall™  
47

# Chateau Wall™



Chateau Wall™ Columbia Blend

RETAINING WALLS

## Chateau Wall™



**RUSTIC**

**SMOOTH**

**!** Special installation procedure required. See pages 86-87 for more details.

Chateau Wall™ opens new horizons in free-standing garden wall and small retaining wall options. Each individual block is treated to give it a rustic look that fits in with the natural Northwest landscape. Available in four sizes and several colors that coordinate well with all our pavers, Chateau Wall's options are endless. Chateau Wall™ is now available as Chateau Moderna™, a non-tumbled finish for a crisp contemporary look.

**!** **WARNING:** Retaining walls over 36" require engineering from a certified engineer.



Breitenbush Blend



Cambridge Blend



**100**  
200x100x100mm • 7.87x3.94x3.94"



**200**  
200x200x100mm • 7.87x7.87x3.94"



**Bevel**  
196x198x136x100mm  
7.72x7.80x5.35x3.94"



**300**  
300x200x100mm • 11.81x7.87x3.94"



**400**  
400x200x100mm • 15.75x7.87x3.94"





Chateau Wall™ Cambridge Blend



Chateau Wall™ Breitenbush Blend



RETAINING WALLS

Chateau Wall™ Columbia Blend



Charcoal



Columbia Blend



Sandstone Blend



Chateau Moderna™ Cambridge Blend

RETAINING WALLS

## Chateau Moderna™



**SMOOTH**

**!** Special installation procedure required. See pages 86-87 for more details.

Our Chateau Wall™ has been extremely popular due to its versatility since its inception. It's always been available in a non-tumbled finish as a non-stock item, but due to popular demand, we're now offering it as a stock item. Get the utility you love from Chateau Wall™ in a smooth, sharp modern aesthetic.



**WARNING:** Retaining walls over 36" require engineering from a certified engineer.



Cambridge Blend



Charcoal



**100**  
200x100x100mm • 7.87x3.94x3.94"



**200**  
200x200x100mm • 7.87x7.87x3.94"



**300**  
300x200x100mm • 11.81x7.87x3.94"



**400**  
400x200x100mm • 15.75x7.87x3.94"



Chateau Moderna™ Cambridge Blend



Custom Chateau Moderna™ Rectangular Fire Pit Cambridge Blend

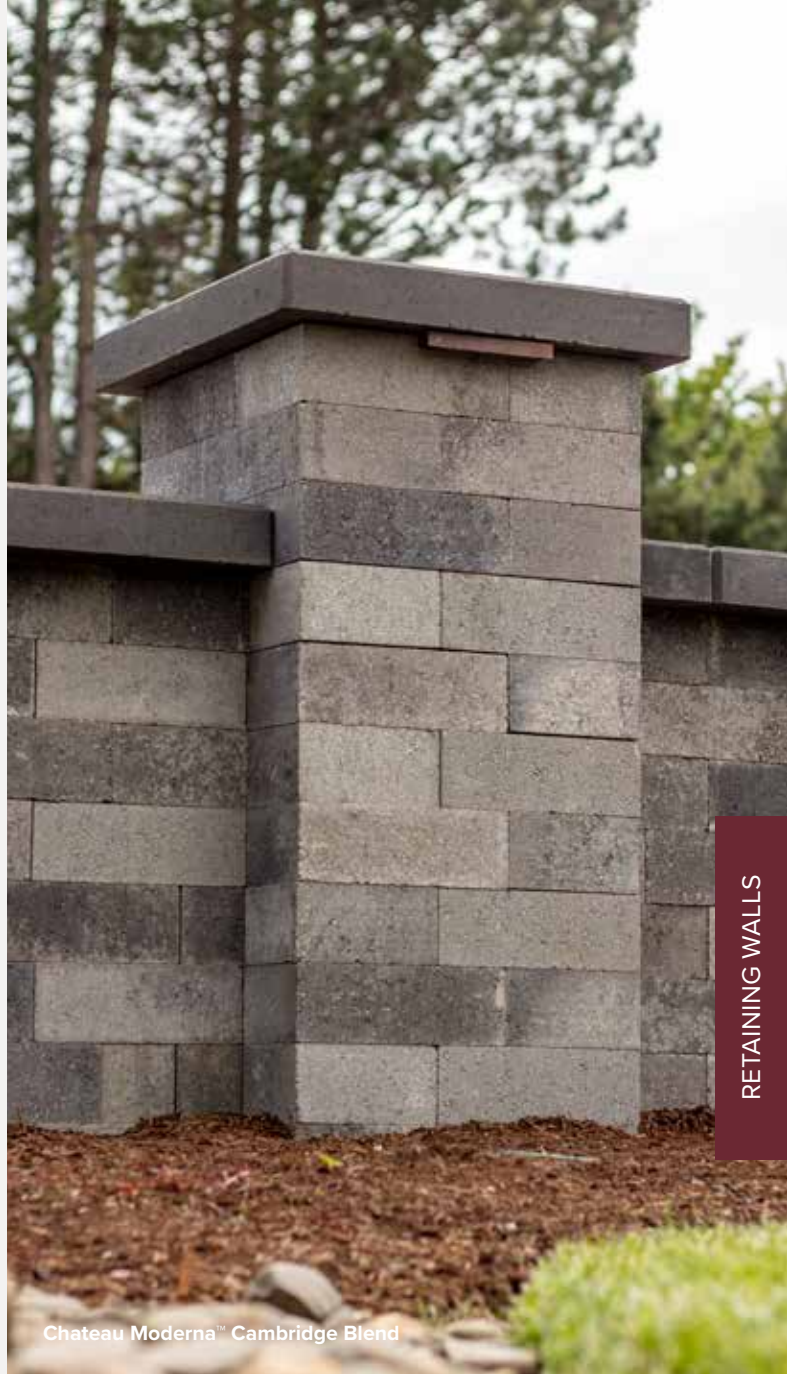

RETAINING WALLS

Chateau Moderna™ Cambridge Blend



**Bevel**  
196x198x136x100mm  
7.72x7.80x5.35x3.94"



**Columbia Blend**



Chateau Moderna™ Cambridge Blend



Chateau Diviso™ Olympian Blend

RETAINING WALLS

# Chateau Diviso™



RUSTIC

TEXTURED



Special installation procedure required. See pages 86-87 for more details.

The rough-hewn split face of Chateau Diviso™ adds a new level of texture to the lineup. Use as a stand-alone block or as an accent with regular Chateau Wall™. Mix it in randomly, or create ribbons of color and texture, your options are limitless. The beveled piece allows you to create curved features, while the corner blocks make columns and corners a snap. The optional cap allows you to finish off your project with a flourish.



**WARNING:** Retaining walls over 36" require engineering from a certified engineer.



**Diviso 200**

200x200x100mm • 7.87x7.87x3.94"



**Diviso 200 Corner**

200x200x100mm • 7.87x7.87x3.94"



**Diviso 300**

300x200x100mm • 11.81x7.87x3.94"



**Diviso Bevel**

297.7x198x200x100mm  
11.72x7.80x7.87x3.94"



**Diviso 100 Corner**

200x198x198x100mm  
7.87x3.94x3.94"



**Diviso 400**

400x200x100mm  
15.75x7.87x3.94"



**Diviso 300 Corner**

300x200x100mm • 11.81x7.87x3.94"



Chateau Diviso™ Olympian Blend



Chateau Diviso™ Olympian Blend

RETAINING WALLS



Chateau Diviso™ Cambridge Blend



**Diviso Column Cap**  
600x600x80mm  
23.62x23.62x3.15"



**Diviso Cap**  
317.8x278x180.2x80mm  
12.51x10.94x7.09x3.15"



Cambridge Blend



Charcoal



Olympian Blend



Tegula Garden Wall™ Columbia Blend

RETAINING WALLS

# Tegula Garden Wall™



**RUSTIC**

**!** Special installation procedure required. See page 88 for more details.

Tegula Garden Wall™ features an old stone look that goes perfectly with the Northwest landscaping style. You can create a variety of free-standing garden walls or small set-back retaining walls, punctuated with optional columns for an attractive finishing touch. Tegula Garden Wall™ can be capped with our Roca Park Stone, Roca Plaza Stone, or Chateau Wall™ blocks.

**!** **WARNING:** Retaining walls over 31" require engineering from a certified engineer.

**Rounded Corners**

Tegula™ Bevel makes tight radius corners easier to build.



244x180x160mm • 9.61x7.09x6.30"



**Bevel**  
177x190x127x160mm • 6.97x7.48x5x6.30"



**Tegula™ Assembly Device**



**Cambridge Blend**



**Charcoal**



**Columbia Blend**



**Sandstone Blend**



Tegula Garden Wall™ Cambridge Blend



Tegula Garden Wall™ Sandstone Blend



Tegula Garden Wall™ Columbia Blend

RETAINING WALLS



Tegula Garden Wall™ Sandstone Blend



Jumbo Nursery Stone™ Straight Face Pewter

# Nursery Stone™ & Jumbo Nursery Stone™



**TEXTURED**



Special installation procedure required.  
See page 89 for more details.

The classic and reliable Nursery Stone™ and Jumbo Nursery Stone™ are built to last. The block's natural, rough-hewn appearance and various size configurations allow you to create walls of all kinds. They are ideal for landscape walls, terrace walls, and meandering borders. Installation is enhanced by the lightweight blocks which are easy to handle.

Nursery Stone™ and Jumbo Nursery Stone™ are manufactured by Basalite Concrete Products, LLC., Redmond, OR • [www.cementproductsmfg.com](http://www.cementproductsmfg.com)

Nursery Stone™ is a licensed trademark of WestBlock Systems. Patent# D433,158

Jumbo Nursery Stone™ is a licensed trademark of WestBlock Systems. Patent# D433,158



**WARNING:** Retaining walls over 36" require engineering from a certified engineer.



Charcoal



Columbia Blend



**Jumbo Nursery Stone™**  
406x305x152mm • 15.98x12.01x5.98"



**Jumbo Nursery™ Straight Face**  
406x305x152mm • 15.98x12.01x5.98"



**Jumbo Nursery™ Step Block**  
406x305x152mm • 15.98x12.01x5.98"



**Jumbo Nursery™ Cap**  
457x330x76mm • 17.99x12.99x2.99"





Jumbo Nursery Stone™ Pewter w/Charcoal cap



Jumbo Nursery Stone™ Straight Face Pewter

RETAINING WALLS



Jumbo Nursery Stone™ Columbia Blend



**Nursery Stone™**  
304x203x101mm • 11.97x7.99x3.98"



**Nursery™ Cap**  
330x228x76mm • 12.99x8.98x2.99"



Pewter



Tan





Gradino™ Step Block Olympic Blend

RETAINING WALLS

# Gradino™ Step Block



**TEXTURED**



Special installation procedure required.

Gradino™ Step Blocks are designed to make step building as quick and as easy as possible. With a rough-hewn split face, Gradino™ Step Blocks match really well with our Jumbo Nursery Wall and our Chateau Diviso blocks.



**Gradino™ Step Block**  
406x305x152mm • 15.98x12.01x5.98"



Charcoal



Desert Tan



Olympian Blend



Pewter



Versa-Cap™ Pewter

# Versa-Cap™



**TEXTURED**

Our new Versa-Cap will fit any standard 12" deep retaining wall block. It has a split face and comes in colors that match most of the block on the market.



**Versa-Cap™**  
457x330x80mm • 17.99x12.99x3.15"

RETAINING WALLS



**Charcoal**



**Desert Tan**



**Olympian Blend**

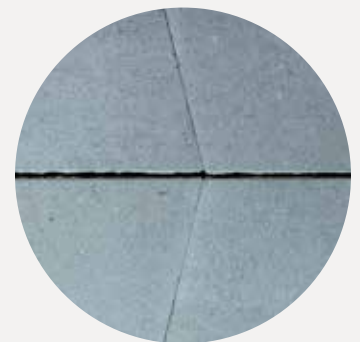

**Pewter**



Murata Wall™ Cambridge Blend

RETAINING WALLS

# Murata™ Retaining Wall System



**SMOOTH**



Special installation procedure required.  
For more details, see pages 90-91 or go to [muratawall.com](http://muratawall.com)

Murata™ is a modular retaining wall which utilizes a rear locating lip for easy assembly. It has a tight, crisp surface finish with strong straight lines and dramatic color blending. The complete system includes some unique corner blocks, which allow you to create columns and posts; along with a dedicated step and post caps. Its high PSI density gives it a high strength-to-weight ratio, as well as excellent color retention.



Cambridge Blend



Olympian Blend



rear tab detail

**MS4020** Standard  
400x295x200mm • 15.75x11.61x7.87"



no rear tab

**MV4020** Variable  
400x295x200mm • 15.75x11.61x7.87"



**MA4020** Angolo (sold as pair)  
400x200x200mm • 15.75x7.87x7.87"

Murata™ Retaining Wall System from Western Interlock. (US Patents #D867,620 S, #D900,341 S, #10,532,488 B2, #D844, 857 S)



**ZERO WALL FAILURES**



Murata™ Cambridge Blend



Murata™ Olympian Blend



Murata™ Cambridge Blend

RETAINING WALLS



Pewter

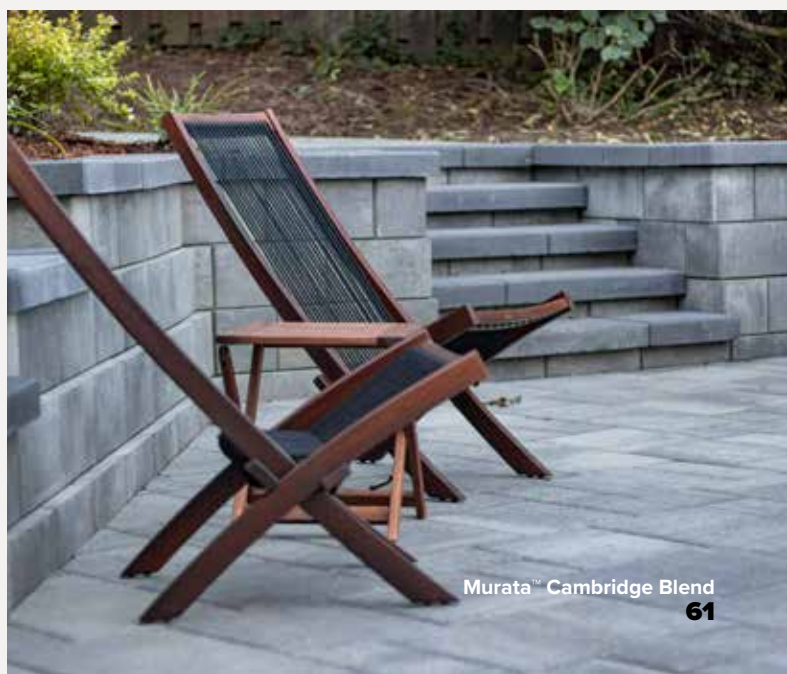

Murata™ Cambridge Blend



Murata™ Cappello Charcoal

RETAINING WALLS

# Murata™ Cappello

 **SMOOTH**

Murata™ Cappello caps are designed to work with the Murata™ retaining wall system. However, they also make a beautiful cap for any of our other wall systems. For instance, Murata™ Cappello 600x600mm column cap fits perfectly on a 20" Chateau Wall™ column.

## Wall Caps



**MC4035** Cappello  
400x350x80mm • 15.75x13.78x3.15"



**MC8035** Cappello  
800x350x80mm • 31.5x13.78x3.15"



**MC7070** Cappello  
700x700x80mm • 27.56x27.56x3.15"

## Column Caps



**MC6060** Cappello  
600x600x80mm • 23.62x23.62x3.15"



**Charcoal**

(only available in Murata™ Cappello)



**Desert Tan**

(only available in Murata™ Cappello)



**Pewter**

# MONACO COPING



Monaco™ Coping Charcoal



Monaco™ Coping Cambridge Blend

## Monaco™ Coping



SMOOTH

It works great for pool edges, steps, accent ribbons, and wall caps; basically anywhere that you want a clean, rounded edge.

It is a standard 305mm (12") length, but it's a little wider at 150mm(5.9"). We've made the height 60mm to match up perfectly with our standard thickness paving stones.

We stock Monaco in solid Charcoal and in Jamestown and Cambridge Blends, which are some of our most popular colors.



Monaco™ Coping  
305x150x60mm • 12x5.9x2.36"



Cambridge Blend



Charcoal



Jamestown Blend



## FIRE PITS & FIREPLACES

---







Tegula Garden Wall™ Fire pit Kit Columbia Blend

# Tegula Garden Wall™ Fire Pit Kit



RUSTIC

If you're looking for a smaller sized fire pit, this one is a favorite. The Tegula Fire Pit Kit includes beveled pieces for quick and easy installation with no cutting. This kit makes it possible to build a backyard fire pit in an afternoon. Its 40" outside diameter tucks into smaller spaces, making it ideal for almost anywhere.



Tegula Garden Wall™ Small Fire Pit Kit  
40" outside diameter\*

FIRE PIT KITS





Chateau Wall™ Fire Pit Kit Charcoal

FIRE PIT KITS

## Chateau Wall™ Fire Pit Kit



RUSTIC

Add ambiance to your backyard with this easy-to-assemble fire pit. This kit includes beveled pieces to eliminate cutting, assembles with glue, and is a super quick way to add warmth to your backyard. It comes with a rustic tumbled finish, a 50" outside diameter, and in several different color options. This is one of our most popular fire pits. It also makes up part of our Outdoor Oasis DIY kit.



Chateau Wall™ Medium Fire Pit Kit  
50" outside diameter



Chateau Wall™ Fire Pit Kit Cambridge Blend  
(shown w/extra row & custom cap)



Chateau Diviso Fire Pit Kit Chateau Blend w/Charcoal cap (shown with custom vent panel and one extra layer)

# Chateau Diviso™ Fire Pit Kit

 **RUSTIC** **TEXTURED**

Chateau Wall™ firepits have always been popular. They're the perfect way to add some ambiance to your backyard setting and ward off the chill of cool evenings. There's a new addition to the fire pit range, the Chateau Diviso™ 50" fire pit. The rough-hewn split face of Chateau Diviso™ adds a new texture, and the four available colorways are sure to enhance your outdoor living area year round.



**Chateau Diviso™ Fire Pit Kit**  
50" outside diameter\*  
(available with matching color or Charcoal cap layer)

FIRE PIT KITS



**Cambridge Blend w/Charcoal Cap**



**Cambridge Blend w/Cambridge Cap**



**Olympian Blend w/Olympian Cap**



**Olympian Blend w/Charcoal Cap**



Chateau Wall™ Moderna Fire Pit Kit Cambridge Blend (shown as part of the Outdoor Oasis kit)

FIRE PIT KITS

## Chateau Moderna™ Fire Pit Kit



SMOOTH

Our Chateau™ fire pit kits have been a perennial favorite with our customers. Now you can get them in a crisp, contemporary finish that matches our smooth pavers and retaining walls.



Chateau Wall™ Medium Fire Pit Kit  
50" outside diameter



Chateau Wall™ Moderna Fire Pit Kit Cambridge Blend w/ Monaco™ cap & Breeo smokeless insert



Deschutes Fireplace Kit Charcoal

# Deschutes Fireplace Kit

 **RUSTIC**

The Deschutes River flows right through the center of the state of Oregon, and just like its namesake, this fireplace deserves center stage. A perfect DIY kit, the Deschutes fireplace can easily be assembled in a weekend or less, comes in all the standard Chateau Wall™ colors, and the eye-catching results are well worth the effort.

## DESCHUTES FIREPLACE KIT

- Chateau Wall™ 300mm
- Chateau Wall™ 200mm
- Chateau Wall™ 100mm
- SEK Surebond adhesives
- Permanent polymer shims
- Fire brick
- Deschutes Hearth
- Deschutes Trim (for firebox)
- Angle iron support
- Deschutes Chimney Cap

## DESCHUTES WOODBOX KIT (optional)

- Chateau Wall™ 300mm
- Chateau Wall™ 200mm
- SEK Surebond glue
- Deschutes Woodbox Cap

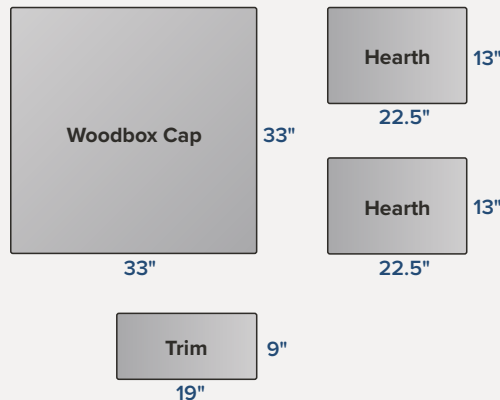

**Deschutes Fireplace Kit**  
 42x44x80" (as shown)  
 75x44x80" (w/ woodbox)  
 Kit shown in Columbia Blend



**PRO TIP:** Want to build a Deschutes fireplace yourself? Watch a step-by-step video here:





Rogue Fireplace Kit Columbia Blend (shown with optional woodboxes)

# Rogue Fireplace Kit



**RUSTIC**

Go Rogue with our large fireplace kit with multiple woodbox options. Choose from the five Chateau Wall™ colors for your kit. Fireplaces can be constructed in a weekend or less. Each kit comes complete with adhesives, fire brick, spark arrestor and Chateau™ blocks. Thorough instructions are provided with each kit for easy assembly!

## ROGUE FIREPLACE KIT

- Chateau Wall™ 300mm
- Chateau Wall™ 200mm
- Chateau Wall™ 100mm
- SEK Surebond glue
- Permanent Polymer Shims
- Fire Brick
- Rogue Hearth
- Rogue Trim (for firebox)
- Angle Iron Support
- Rogue Chimney Cap

## ROGUE WOODBOX KIT

*(optional)*

- Chateau Wall™ 300mm
- Chateau Wall™ 200mm
- SEK Surebond glue
- Deschutes Woodbox Cap

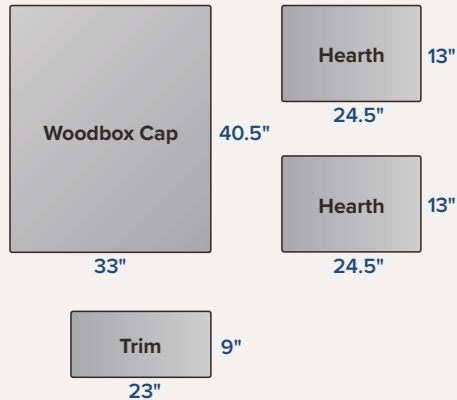

**Rogue Fireplace Kit**  
 110x51x88" (as shown)  
 47x51x88" (w/o woodboxes)  
 Kit shown in Breitenbush Blend



Chateau Moderna™ Deschutes Fireplace Kit Cambridge Blend (shown with custom Chateau Diviso™ decorative band)

# Chateau Moderna™ Fireplace Kits

 **SMOOTH**

Want a fireplace that matches your clean contemporary landscape design? Look no further than our Chateau Moderna™ fireplace kits. This finish is available in both our Deschutes and Rogue fireplace sizes, so there's sure to be one that fits your space.

## DESCHUTES FIREPLACE KIT

- Chateau Wall™ 300mm
- Chateau Wall™ 200mm
- Chateau Wall™ 100mm
- SEK Surebond adhesives
- Permanent polymer shims
- Fire brick
- Deschutes Hearth
- Deschutes Trim (for firebox)
- Angle iron support
- Deschutes Chimney Cap

## DESCHUTES WOODBOX KIT

- (optional)
- Chateau Wall™ 300mm
  - Chateau Wall™ 200mm
  - SEK Surebond glue
  - Deschutes Woodbox Cap

## ROGUE FIREPLACE KIT

- Chateau Wall™ 300mm
- Chateau Wall™ 200mm
- Chateau Wall™ 100mm
- SEK Surebond glue
- Permanent Polymer Shims
- Fire Brick
- Rogue Hearth
- Rogue Trim (for firebox)
- Angle Iron Support
- Rogue Chimney Cap

## ROGUE WOODBOX KIT

- (optional)
- Chateau Wall™ 300mm
  - Chateau Wall™ 200mm
  - SEK Surebond glue
  - Deschutes Woodbox Cap



**Rogue Fireplace Kit**  
110x51x88" (as shown)  
47x51x88" (w/o woodboxes)  
Kit shown in Cambridge Blend

**Deschutes Fireplace Kit**  
42x44x80"  
75x44x80" (w/ woodbox)

**Chateau**  
MODERNA™



# INSPIRATION GALLERY

---







La Lastra™ Cambridge Blend



La Lastra™ Pewter



INSPIRATION GALLERY



Granite Stone & Cobble Rotundo Cambridge Blend



La Pietra™ Jamestown Blend



INSPIRATION GALLERY

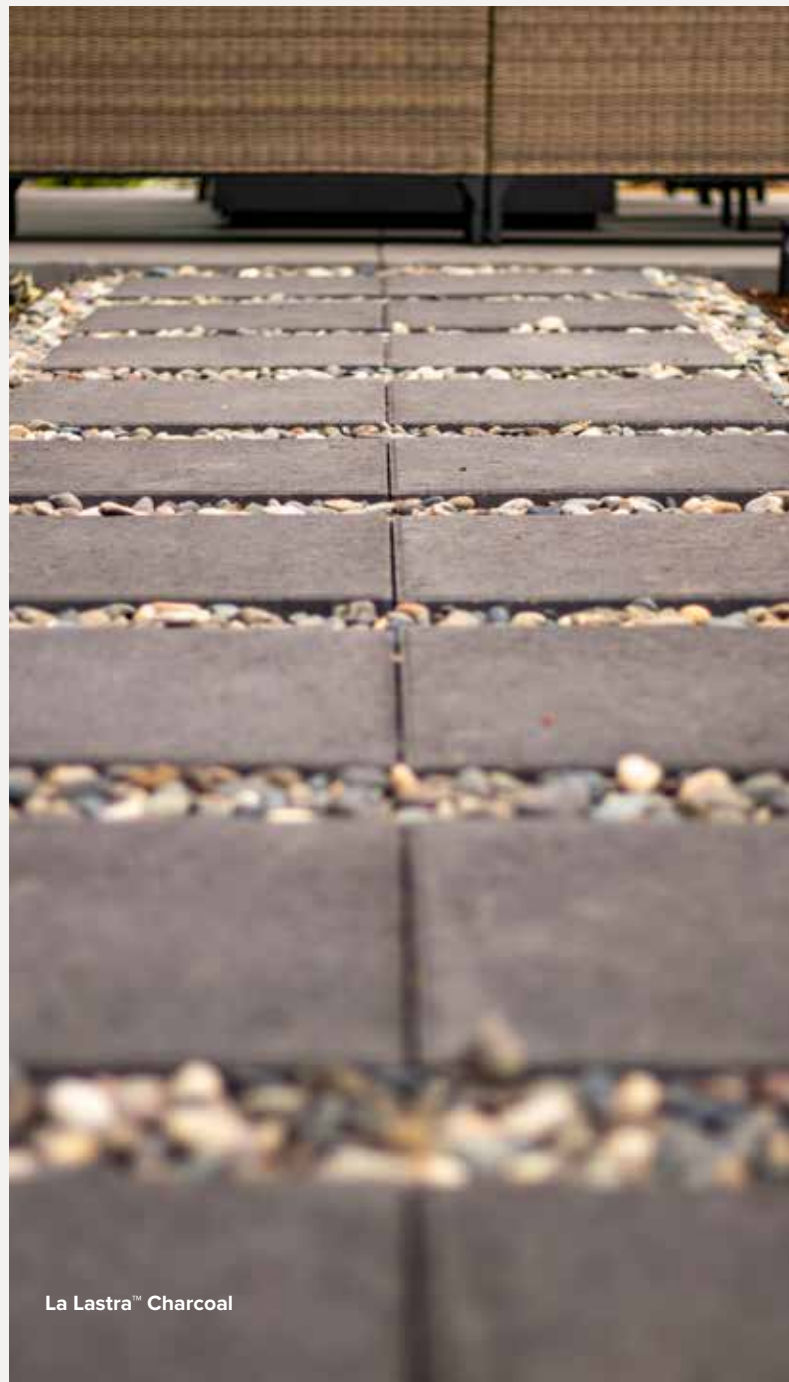

La Lastra™ Charcoal



INSPIRATION GALLERY



Granite Stone Cambridge Blend

La Lastra™ Pewter w/Chateau Moderna Cambridge Blend



Leiden Cambridge Blend



INSPIRATION GALLERY





Murata™ Cambridge Blend



INSPIRATION GALLERY

Leiden Cambridge Blend

# Paving Stone Installation

Western Interlock paving stones are easily installed by homeowners. No prior experience is needed, just careful work and attention to detail. The following list of tools will make your project possible and enable you to create the long lasting results you desire:

- Shovel
- Rubber Mallet
- Stakes
- String Line
- Hand Tamper
- Plate Compactor
- 6' Level, laser level or transit

## MATERIALS NEEDED:

**Gravel base:**  $\frac{3}{4}$ " minus crushed rock; typically 4"-6" of compacted base should be used for pedestrian traffic, or 6"-12" for vehicular or industrial traffic. When using a 4" base, 1 yard of gravel will cover 80 square feet.

**Bedding Sand:** Coarse concrete sand is recommended. A uniform depth of 1" of sand is recommended. 1 yard of sand covers 200 square feet.

**Pavers:** Determine the total square footage of your project (length x width = square feet) adding 5-10% for cuts and extra pavers that might be needed later. To estimate the number of pieces you will need, multiply the square footage by the pieces per square foot. (Square foot x Pieces per square foot = Total number of pavers needed) You can find the data on pages 78-79.

**Edge Restraint:** All exposed edges (not up against a permanent structure) must be restrained. Measure the linear feet of all exposed edges to determine the amount of edge restraint needed.

## INSTALLATION:

1. Measure and stake the desired area you intend to pave. Mark the outline of your project with stakes every 4-6" and at each corner; these stakes should be 6" outside of the edge of the planned area. Tie a string line at the level you want your finished project height.
2. Excavate 4"-6" beyond finished size, remove any loose dirt or sod to a minimum of 5"-6" below the finished grade (8" or more for vehicular traffic). This makes room for 3"-6" of compacted gravel, 1" of sand and 2  $\frac{3}{8}$ " paving stones. The more time and effort you put into your base preparation, the better your paving stone project will look.
3. Compact sub-grade, backfill with crushed  $\frac{3}{4}$ " minus aggregate and compact again. Slope and grade are important for proper drainage. Assure a minimum of  $\frac{1}{8}$ " per foot drop, not to exceed  $\frac{1}{2}$ " per foot. When finished with the base, it should be smooth and flat and reflect the final grade of your pavers.
4. Lay screed rails (1" outside diameter pipe or square tube) as guides, spread sand between rails and then use a straight wood 2" x 4" crossway to spread sand smooth and level to an even 1" depth. Remove the rails and fill in the voids left by the guides with sand and trowel smooth by hand or with the backside of a push broom. Don't walk on or compact the sand.
5. Determine your laying pattern. Starting in a square corner with a permanent edge, lay paving stones down lightly on the sand bed. Install rows of pavers, checking with a string line every 4 feet or so, across the front of the laying edge to maintain a straight line. Stones may be marked with a wax crayon, and cut with a diamond blade wet saw (recommended), a diamond blade for a skill saw or a stone splitter. Try to keep cut pieces along the edges to a size of at least half of a full-size paving stone.
6. Install plastic edge restraint (or similar product) along edges that are not up against a permanent structure. Edge restraint should rest on the compacted aggregate base and contain the sand and maintain the position of the paving stone.
7. Sweep pavers clean prior to compacting. Using a vibratory plate compactor, set the stones into the sand base. Start along the outside edge and work toward the center. This will level your paving stone project.
8. After compacting, sweep paver joints full of concrete sand and compact again.

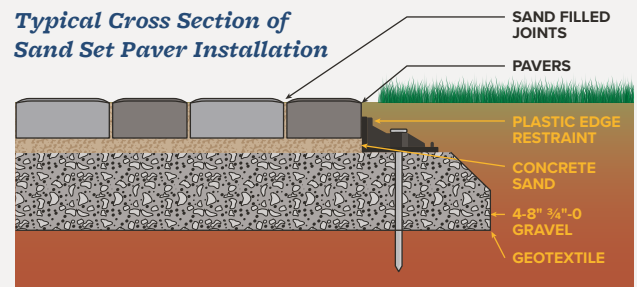

# Installation Patterns

There are many patterns that you can use in the installation of paving stones. We have provided some basic patterns below. Keep in mind that many of the paving stone families have multiple stone sizes that module together, expanding your creative options. Patterns are for design inspiration only. Any percentages listed are approximate. The installer is responsible to calculate and purchase the correct amount of material.

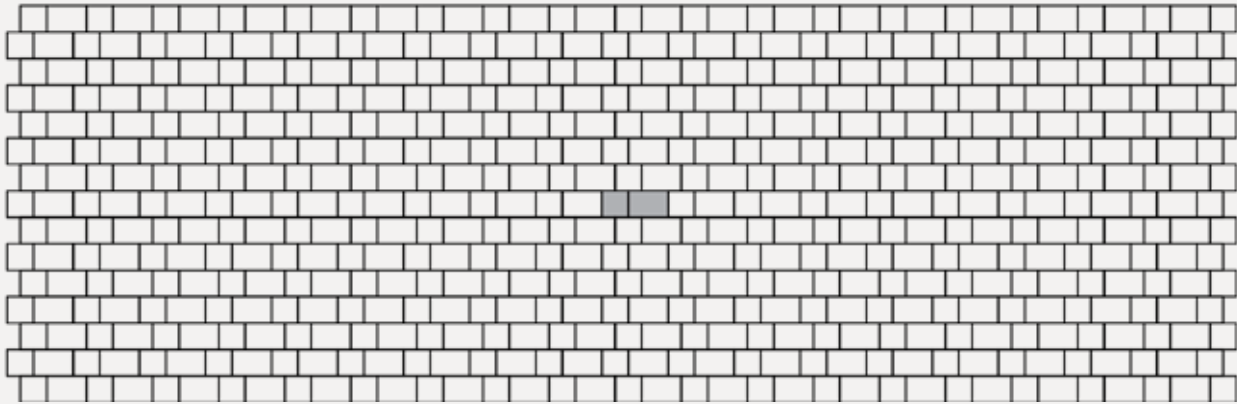

## Two Stone Running Bond:

Works with any stone that has more than one size it can module with (*typical ratio 60% rectangles, 40% squares*)

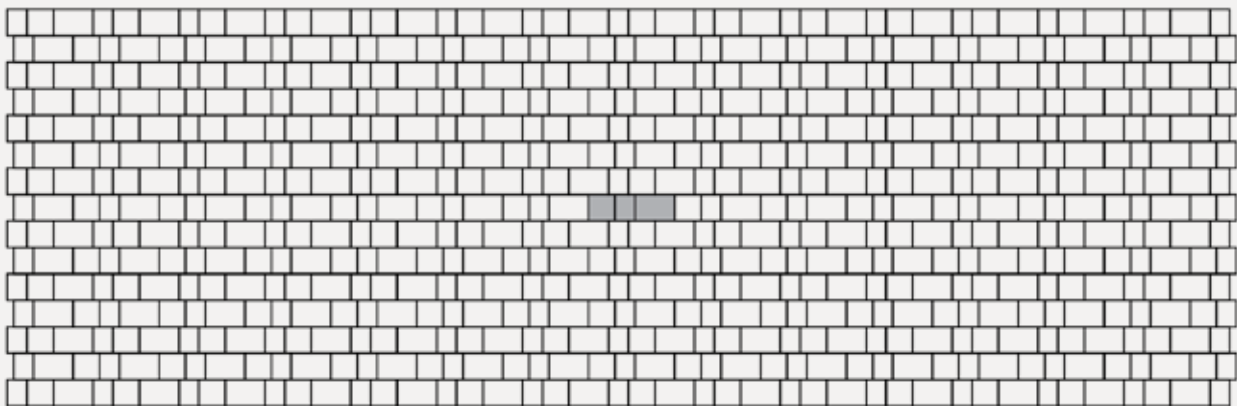

## Three Stone Running Bond:

Works with any stone that has more than two sizes it can module with (*typical ratio 46% large rectangles, 31% squares, 23% small rectangles*)

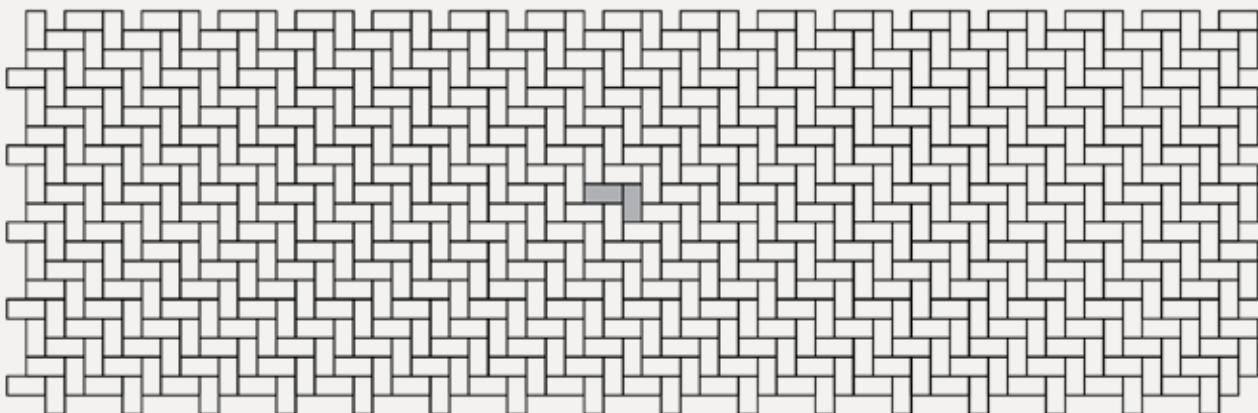

## Herringbone 90 Degree:

Works with any rectangle stone (*100% one stone*)

# Installation Patterns

---

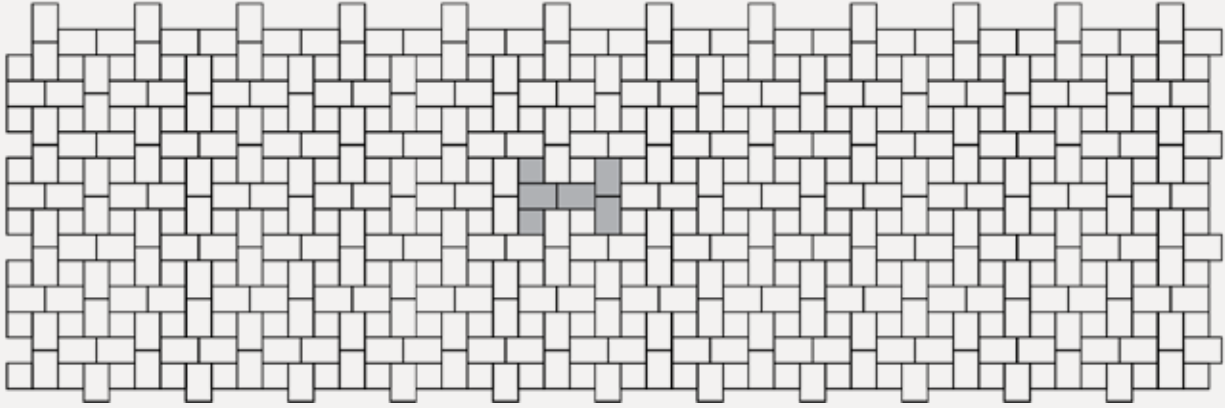

## Muster K (I pattern):

Works with any stone that has a rectangle and square module units (*typical ratio 73% rectangles, 27% squares*)

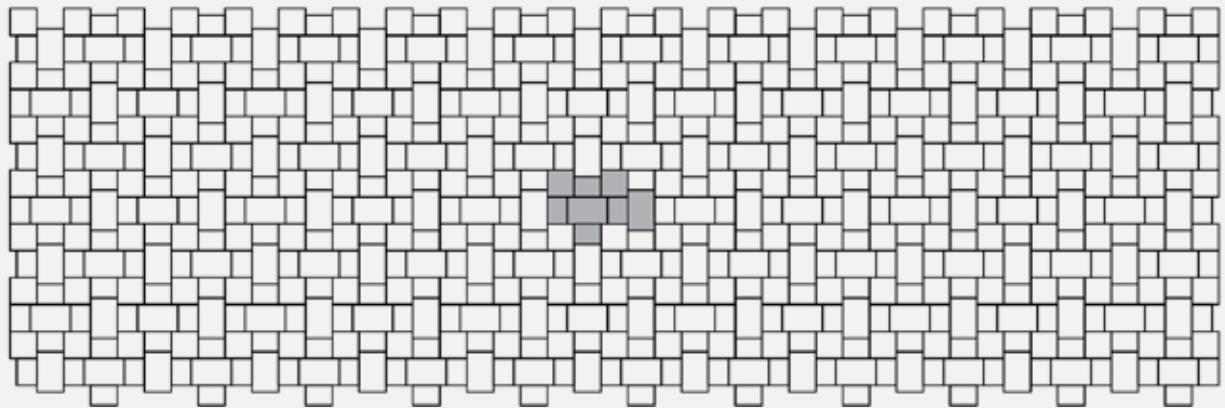

## Three Stone I Pattern:

Works with Camino Stones (*37% large rectangles, 27% squares, 36% small rectangles*)



## Five Stone Pattern:

Works with Granite Stone and Leiden (*41% Arena, 27% Plaza, 18% Park, 9% Holland, 5% Half Holland*)



# Installation Patterns

---

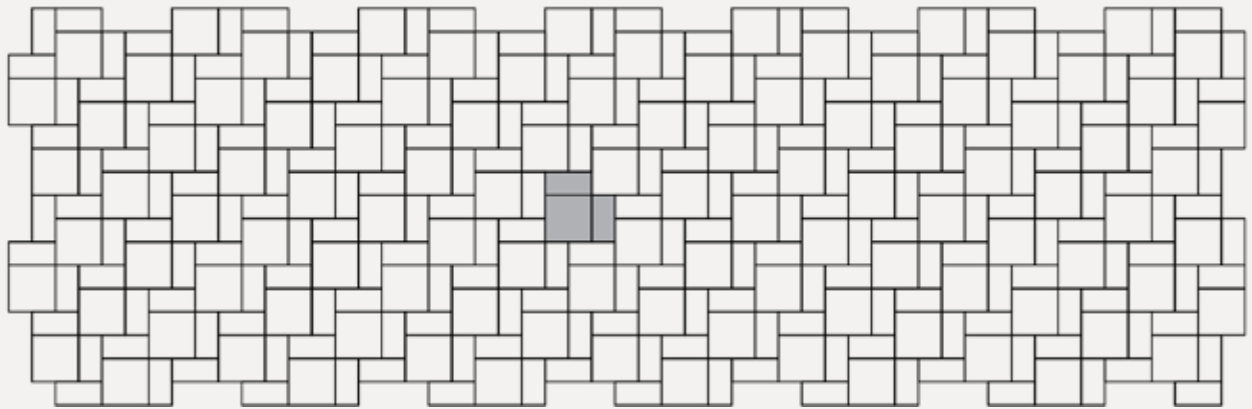

## Brickweave Pattern:

Works with Park & Holland Stone and Park Permeare & Holland Permeare (50% Park, 50% Holland)

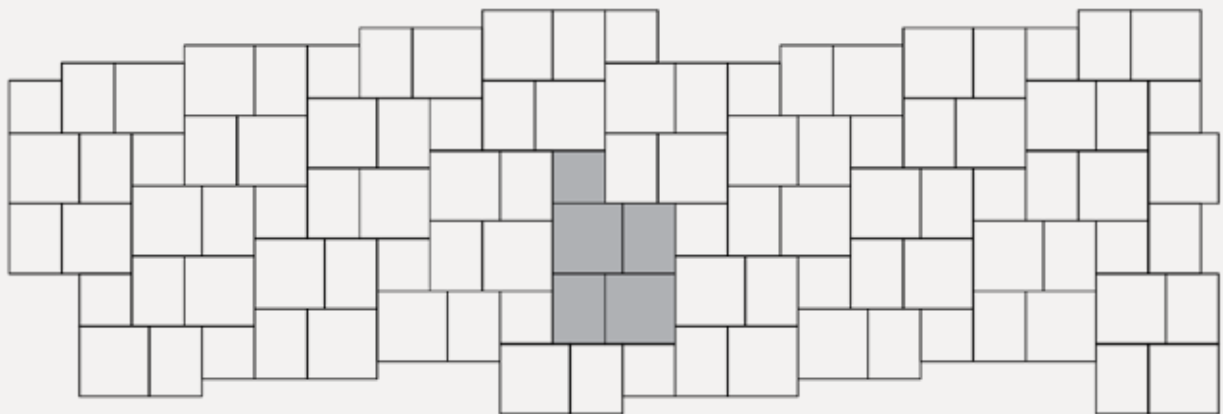

## Three Stone Pattern:

Works with Arena, Park & Plaza Stone (granite or flat top finish) (47% Arena, 21% Park, 32% Plaza)

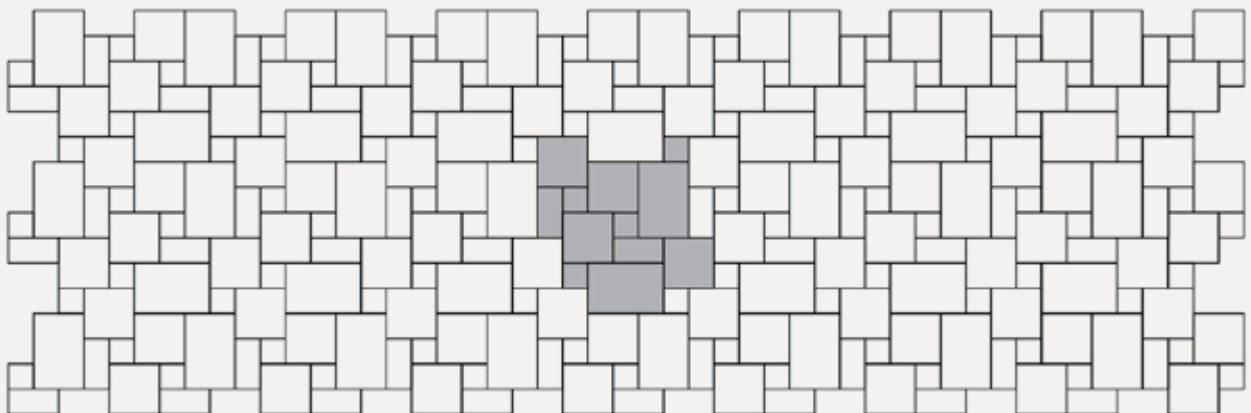

## Palatial Versailles Pattern:

Works with Leiden, La Pietra, & La Pietra Moderna (i.e. 34% Plaza, 44% Park, 11% Holland, 11% Half Holland)

# Installation Patterns

---

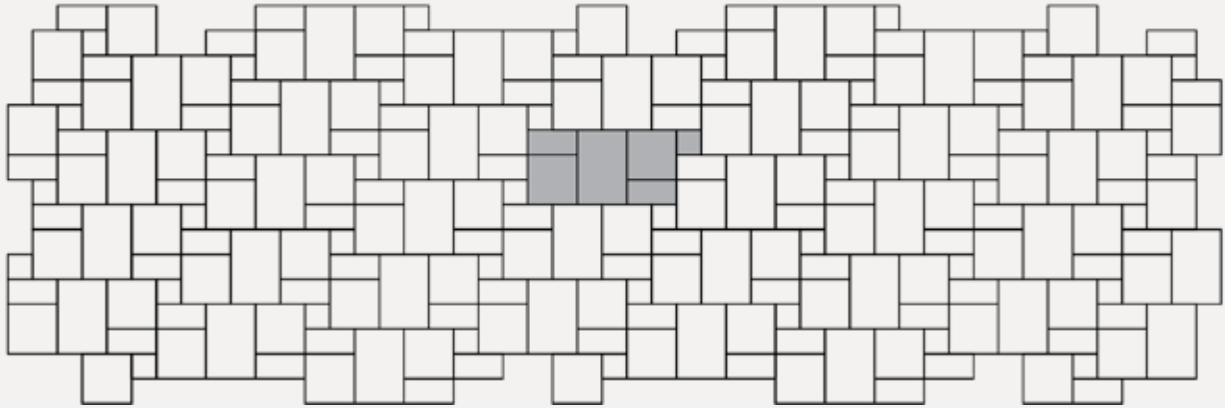

## Modified Marseilles Pattern:

Works with Leiden, La Pietra, & La Pietra Moderna  
(i.e. 30% Plaza, 40% Park, 20% Holland, 10% Half Holland)

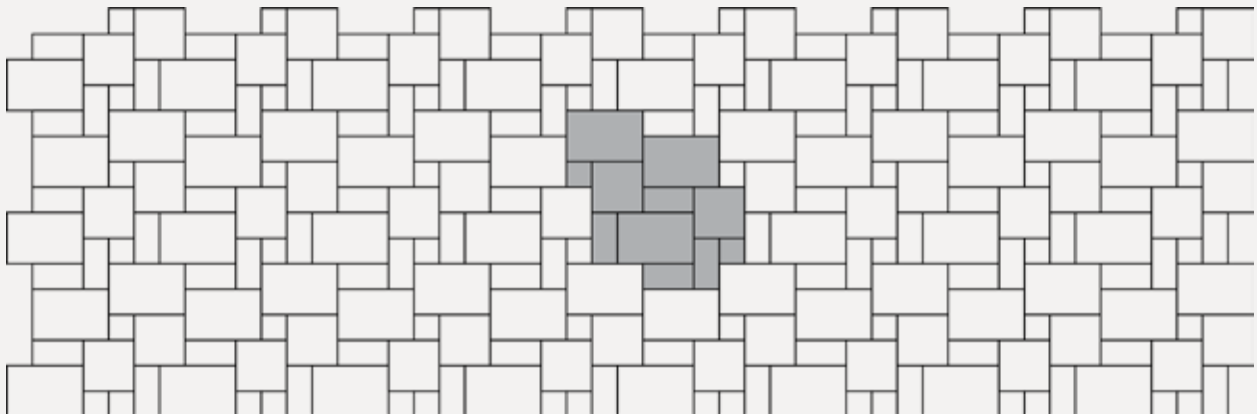

## Opus II Pattern:

Works with Leiden, La Pietra, & La Pietra Moderna  
(i.e. 50% Plaza, 22% Park, 22% Holland, 6% Half Holland)

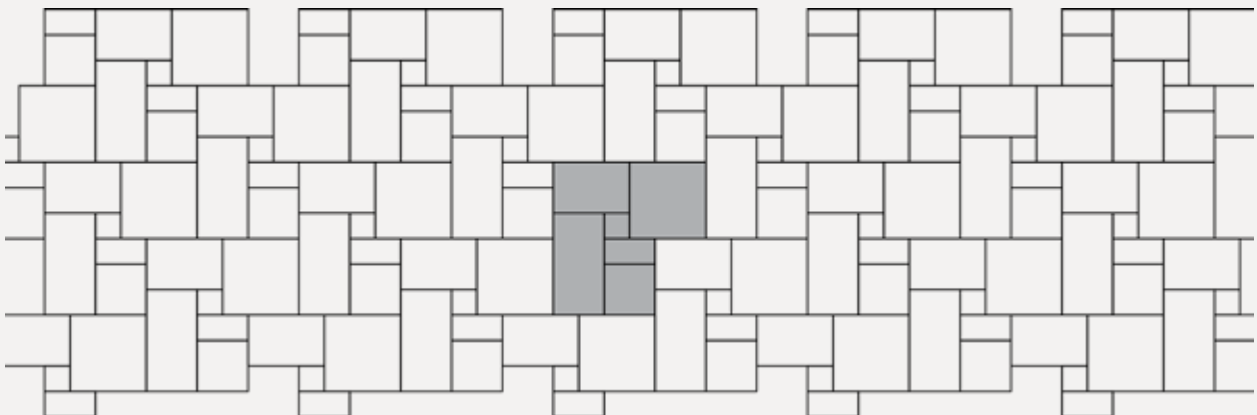

## Paladio Pattern:

Works with Leiden, La Pietra, & La Pietra Moderna  
(i.e. 30% Arena, 27% Double Park, 20% Plaza, 14% Park, 6% Holland, 3% Half Holland)

# Installation Patterns

---

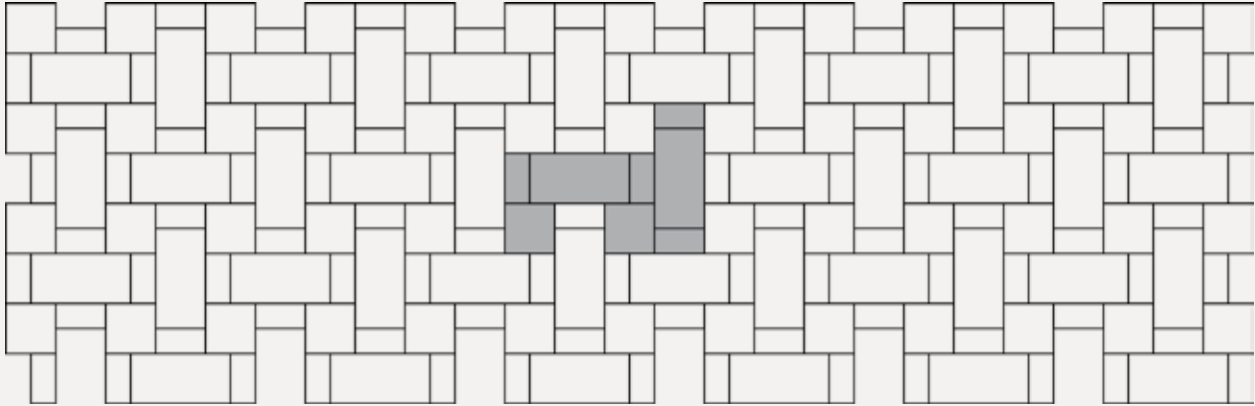

## Large Three Stone I Pattern:

Works with Leiden (*i.e.* 50% Double Park, 25% Park, 25% Holland)

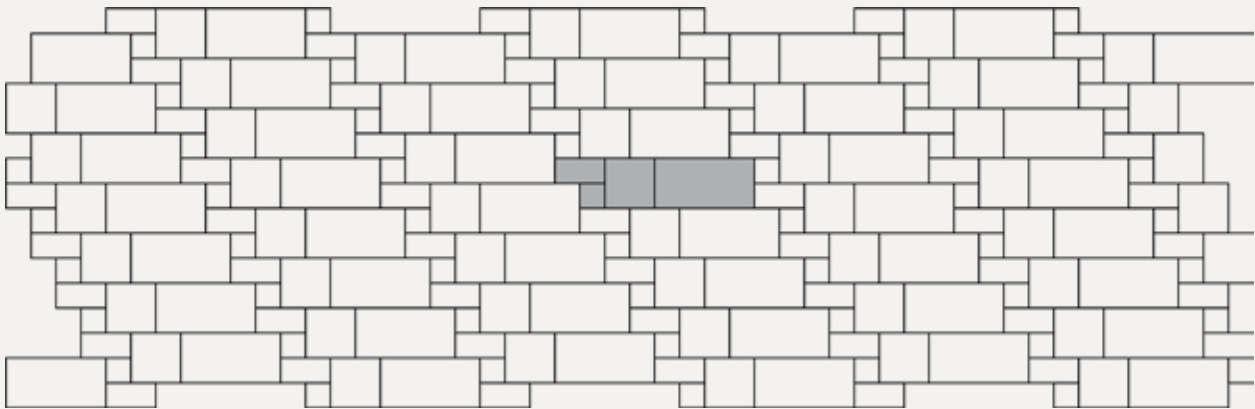

## Italia Pattern:

Works with Leiden, La Pietra, & La Pietra Moderna  
(*i.e.* 53% Double Park, 27% Park, 13% Holland, 7% Half Holland)

# Random Layout

---

The secret to laying a truly random layout is to never let four corners come together. If you end up with four corners meeting, simply swap out one of the stones for a stone with a different shape.

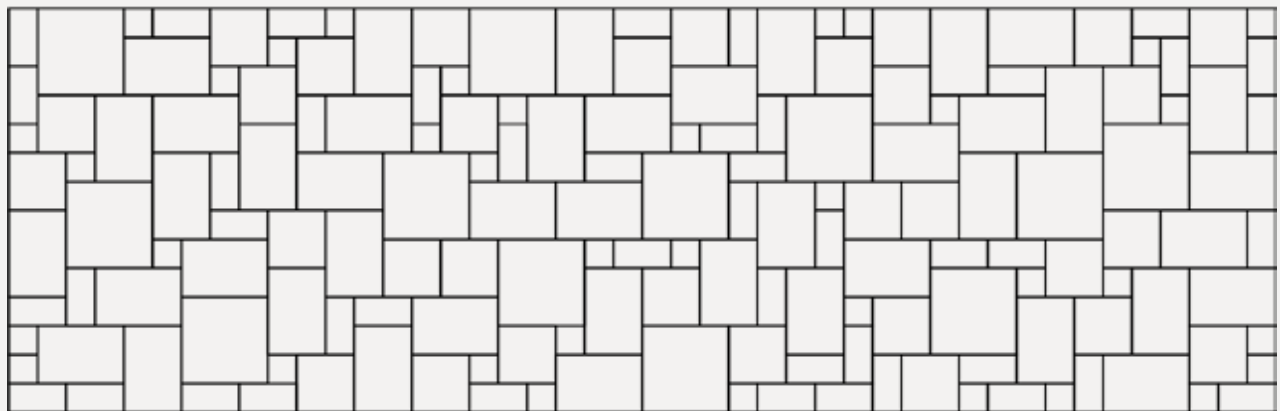

## Five Stone Random Layout:

Works with any stone combination that has five sizes that module together (*La Pietra™ shown - ratios will vary*)

# Border Patterns

---

There are two excellent reasons to add a paver border to your hardscape: enhance the design and tie in your field stones. There are two main design aspects to consider: color and pattern. Regarding color, you'll want to select either a consistent border or a contrast border. Regarding patterns, you'll have to consider if you wish to lay a soldier course or a sailor course.

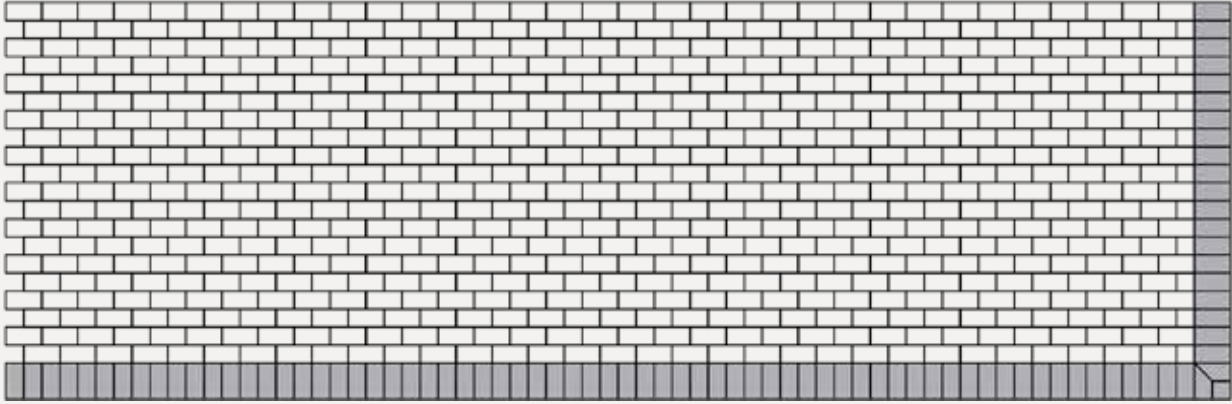

## Soldier Course:

This border is achievable with any rectangle stone like Holland, Plaza, Camino Large Rec and Camino Small Rec.

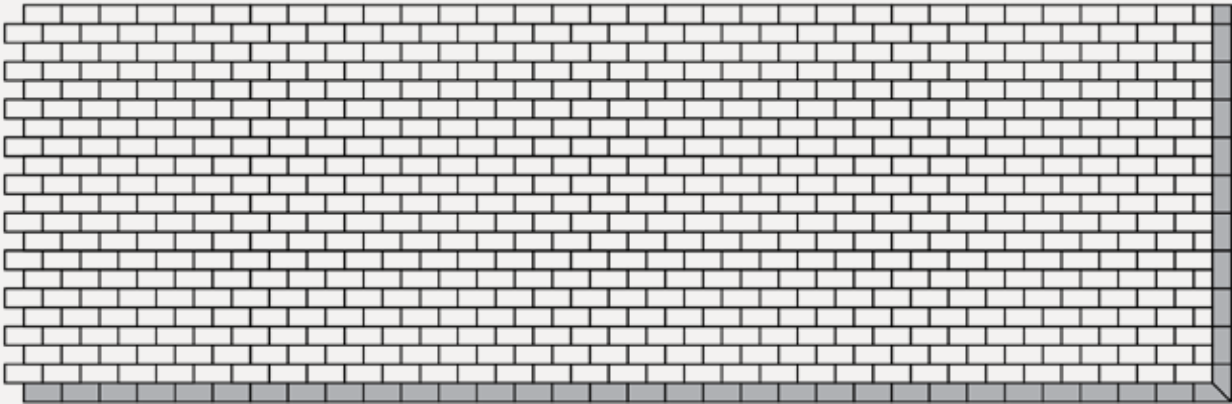

## Sailor Course

This border is achievable with any rectangle stone like Holland, Plaza, Camino Large Rec and Camino Small Rec.

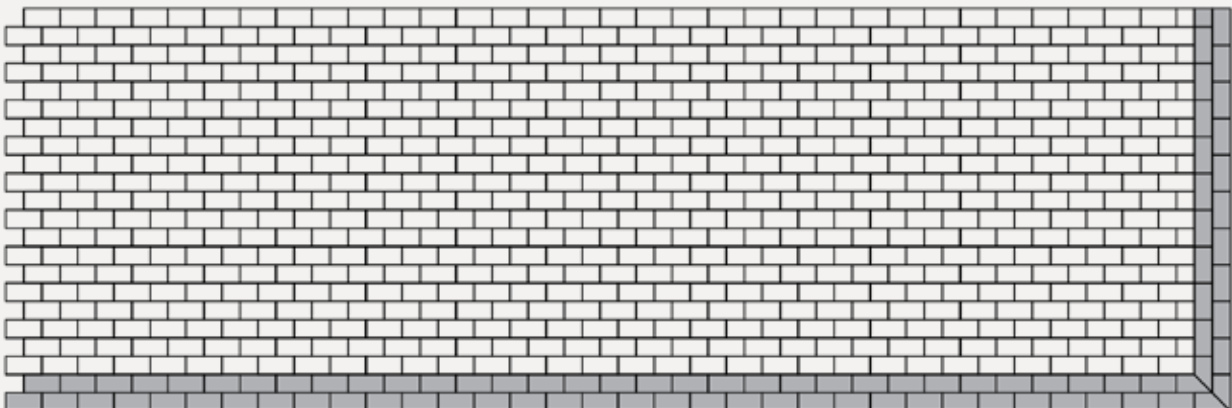

## Double Sailor Course

This border is achievable with any rectangle stone like Holland, Plaza, Camino Large Rec and Camino Small Rec.

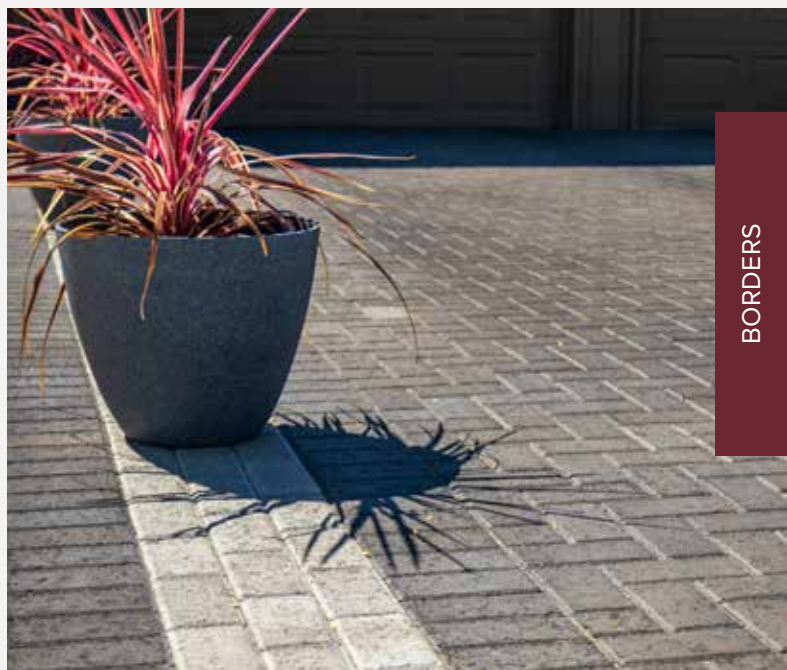

BORDERS



# Chateau Wall™ Installation

Chateau Wall™ is an easy to use wall system that utilizes four different sized units which can be used individually or in combination. This unique product can be used for retaining walls, fences, columns and steps to produce a very unique satisfying project.

## BASIC GRAVITY WALL INSTALLATION:

### Planning Your Project

Prepare a layout for your Chateau Wall™ project on paper. Projects that retain soil and are over 36" high should be engineered. Determine the face square feet of wall and any columns you will have. When calculating wall face square footage, remember that you will have at least the first layer of block buried below the finished soil grade. Decide which block sizes you want to use, and then calculate the quantity of each product size you need. Also consider the type of caps you would like to use. Mark out on the ground the parameters of the project. Use a string line to lay out long straight areas of the project, and to help with curves, use a garden hose or PVC pipe.

### 1. Preparing the Base

Excavate the soil 10"-12" below grade and at least 4" wider on each side than the blocks you are laying. Refer to the installation diagrams for details and better understanding on varied types of projects. With unstable soils, increase the depth of excavation as required to allow for a deeper base. Place ODOT ¾"-0 gravel into the excavation area to a minimum depth of 6" and level it. Next, compact the gravel with a hand tamper or plate compactor. Make sure that you have a minimum of 12" of excavation behind the wall for gravel back fill. This may need to be increased, depending on soil type.

### 2. Positioning the Bottom Course

Set the bottom course of block at the desired position on top of the prepared gravel. Using a large rubber mallet and a level, adjust the block until it is level, end to end, and front to back. Set the adjacent blocks in the same manner, using a string line or a level to keep long runs straight and flat.

### 3. Building and Backfilling

Place two ¾" beads of Western Interlock approved flexible construction adhesive on top of the base course. Set the next course of block on top of the adhesive, offsetting the joints between the blocks on each consecutive course, and continue in this manner along the entire length of the wall. Retaining walls require a set back of ¾" per course to obtain the necessary set back angle. Accomplish this by using a square ¾" piece of wood or a tape measure to

space each block back the required amount. Continue this process one layer at a time until the desired height is obtained. Retaining walls require backfill of ODOT ¾"-0 gravel to within 6" of the finish height. Backfill and compact behind each course as the wall is built. Use a masonry saw to make any necessary cuts.

### 4. Finishing the Wall

The Chateau Wall™ does not require a separate cap. However, depending on the look desired, there are several options available. Any of the Western Interlock paving stones that have a width of 8" or more can be used, as well as Chateau Wall™ 300s turned sideways. If you want a cleaner look, Murata™ Cappello make perfect caps for Chateau Wall™. Large Murata™ Cappello post caps for columns are also available, along with precast textured post caps.

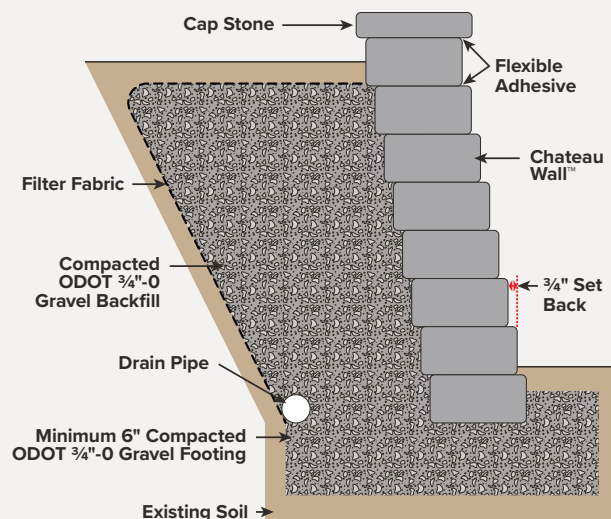

*Battered Gravity Retaining Wall*

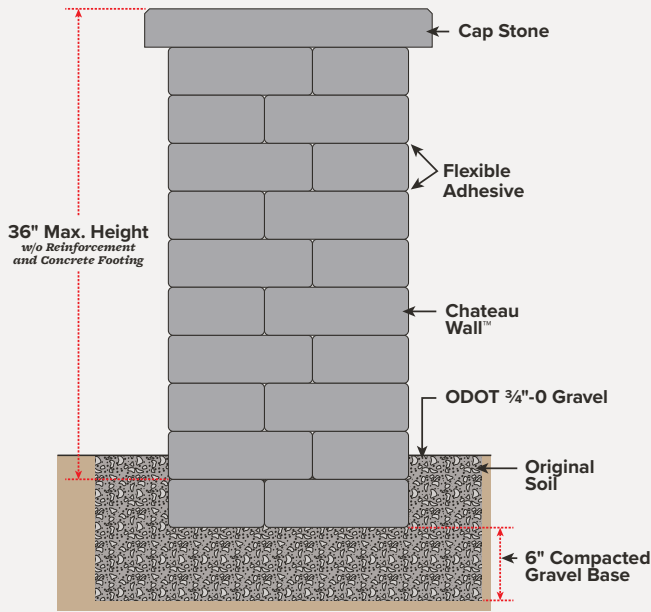

**Free-standing 20" Column**

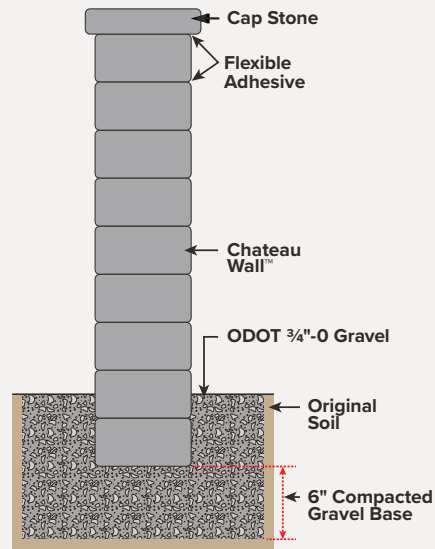

**Non-Retaining Vertical Wall**

**Four Block 300s 20" Column**

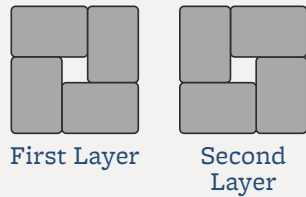

**Four Block 400s 24" Column**

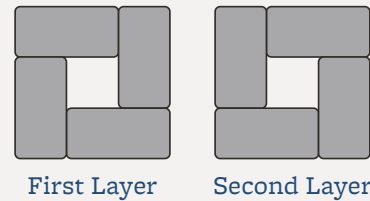

**Column Tie In To Wall**

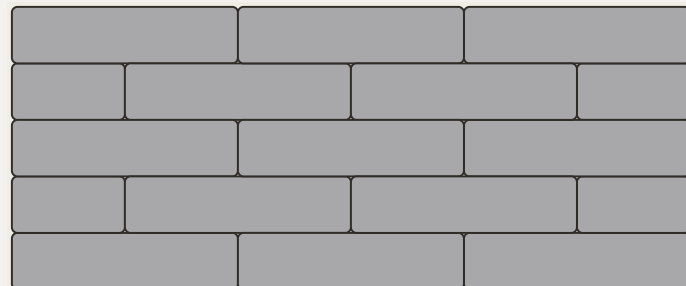
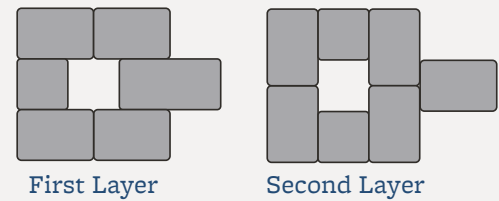

**Half Bond:** 100% 400mm blocks w/ one or two 200mm block starter blocks per course

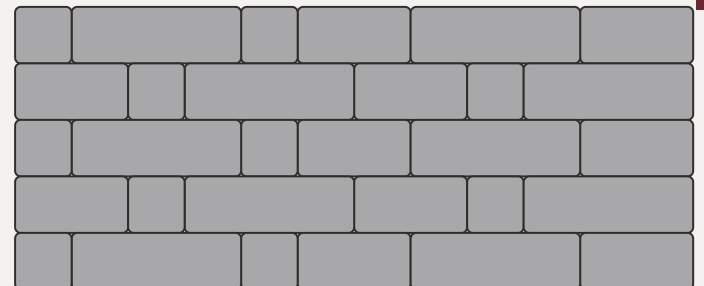

**Running Bond:** Small—50% 300mm, 33% 200mm & 17% 100mm, Large— 50% 400mm, 33% 300mm & 17% 200mm

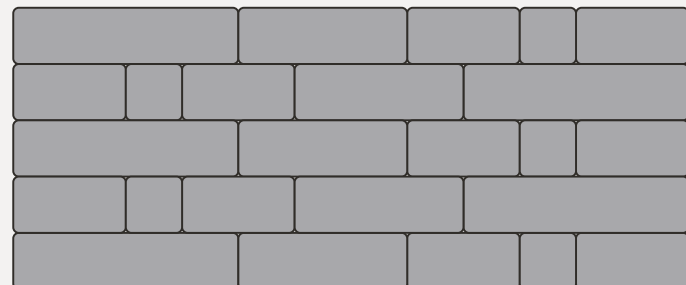

**Running Bond:** All four sizes—35% 400mm, 40% 300mm, 20% 200mm & 5% 100mm blocks

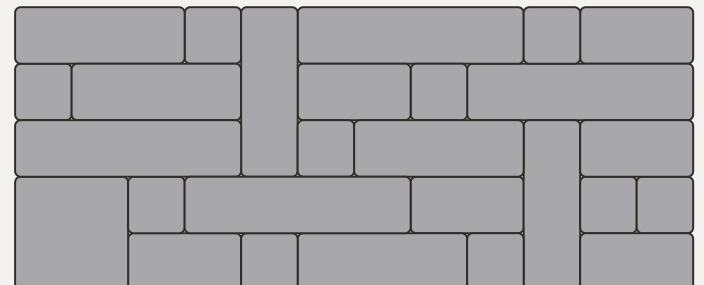

**Random:** Various 400mm, 300mm, 200mm & 100mm blocks w/ jumper blocks

# Tegula Garden Wall™ Installation

Tegula Garden Wall™ is an easy do-it-yourself decorative and gravity retaining wall (up to 36" tall). Tiered walls, garden walls and planters (including those with curves and corners) are all easily installed.

## GRAVITY WALL INSTALLATION:

### 1. Planning Your Project

Prepare a layout for your Tegula Garden Wall™ project. Projects that retain soil and are over 36" high should be engineered. Determine the face square feet of wall and any columns you will have. When calculating wall face square footage, remember that you will have at least the first layer of block buried below the finished soil grade.

### 2. Preparing the Base

Excavate the soil 10"-12" below grade and at least 4" wider on each side than the blocks you are laying. Refer to the installation diagrams for details and better understanding on varied types of projects. With unstable soils, increase the depth of excavation as required to allow for a deeper base. Place ODOT ¾"-0 gravel into the excavation area to a minimum depth of 6" and level it. Next, compact the gravel with a hand tamper or plate compactor. Make sure that you have a minimum of 12" of excavation behind the wall for gravel back fill. This may need to be increased, depending on soil type.

### 3. Positioning the Bottom Course

Set the bottom course of block at the desired position on top of the prepared gravel. Using a large rubber mallet and a level, adjust the block until it is level, end to end, and front to back. Set the adjacent blocks in the same manner, using a string line or a level to keep long runs straight and flat.

### 4. Building and Backfilling

Before setting the next course, place an assembly device or a small ball of mortar in the top groove, or apply a bead of approved adhesive on the surface of the block. Set each additional course in the same manner, insuring that each new block is resting on the two blocks below it. Continue this process one layer at a time until the desired height is obtained. Retaining walls require backfill of ODOT ¾"-0 gravel to within 6" of the finish height. Backfill and compact behind each course as the wall is built. Use a masonry saw to make any necessary cuts.

### 5. Finishing the Wall

Place a cap on the top course, using an approved flexible adhesive. Roca paving stones or Murata™ Cappello caps may be used.

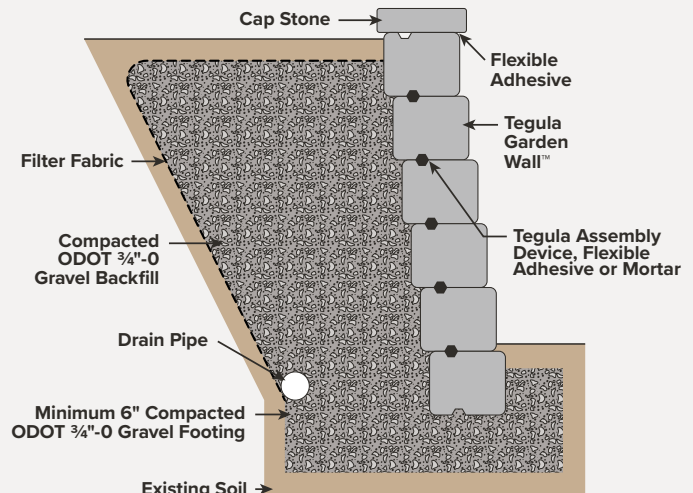

*Tegula™ Set Back Retaining Wall*

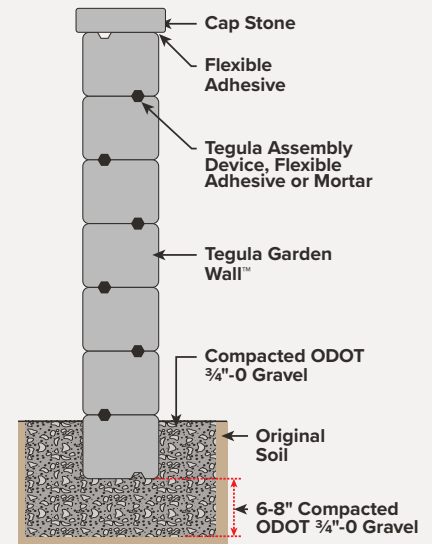

*Tegula™ Non-Retaining Vertical Garden Wall*

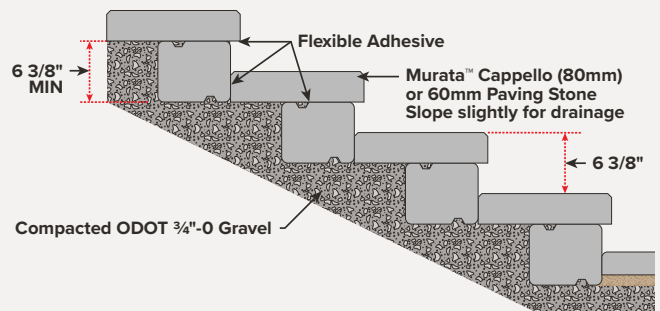

*Tegula™ Steps Side View*



# Modular Retaining Wall Installation\*

Modular retaining walls are easy, do-it-yourself retaining walls. Here are some helpful hints to enable you to achieve the results you desire in a retaining wall project. For more assistance, contact our knowledgeable office staff.

## INSTALLATION:

**\*General installation guidelines apply to all lip-type retaining walls such as: Slope Block™, Nursery Stone™ and Jumbo Nursery Stone™.**

### 1. Planning Your Project

Prepare a layout for your modular retaining wall project. To help plan the number of blocks you will need for your project, multiply the face area times pieces per square foot to figure the number of blocks required. For help measuring curves, lay a garden hose along the proposed length of your wall; then straighten it out and measure its length.

### 2. Preparing the Base

Excavate the soil in the location where the retaining wall is to be, assuring adequate space on the rear side of the wall for gravel backfill. The amount of gravel fill will vary on application, but should not be less than 12". Dig a trench for the first course of stone 30" wide by 12" deep. Fill the first 6" of the trench with ODOT ¾"-0 gravel and compact well, making sure that the gravel is level. Place filter fabric against the back wall of the excavation. (Refer to the diagrams)

### 3. Positioning the Bottom Course

Set the bottom course of block at the desired position on top of the prepared gravel. Using a large rubber mallet and a level, adjust the block until it is level, end to end, and front to back. Set the adjacent blocks in the same manner, using a string line or a level to keep long runs straight and flat.

### 4. Building and Backfilling

Set the next course, making sure that the joints do not line up with the previous course. Back fill with ODOT ¾"-0 gravel and compact again before setting the next course. Place all the remaining courses until the wall has reached your desired height. Use the compacted gravel back fill to keep it straight by tamping lightly behind the rear of the stones, maintaining the same vertical angle from top to bottom.

### 5. Finishing the Wall

Set the top course and back fill to within 3" of the top. Finish back fill area with soil to the desired height. The top course can either be held in place by gravity, or fixed with an approved flexible adhesive. Modular walls can be capped off with Murata™ Cappello, Arena Stone, or any wetcast caps if desired.

## IMPORTANT NOTES:

- A drainage pipe should be used as shown in illustrations to prevent a problem with excessive water in the retained area.
- The standard wall angle set back is 12°. If a different angle is required, then the angle the first course is set at must be adjusted to accommodate the different angle. This angle is maintained as the following courses of stone and gravel are placed.
- Engineering is required on walls over 36" high. Call manufacturer for details.
- Cutting may be necessary for 90 degree corners and possible to maintain the batter on the different courses.

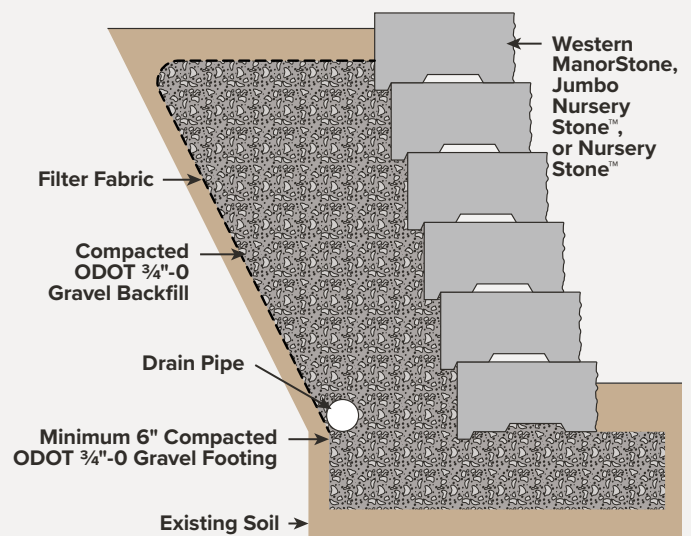

# Murata™ Battered Wall Installation

The Murata™ retaining wall system's advantages are that it is made with hollow dry cast units that can be carried without special equipment. The self-aligning tabs allow for highly accurate and quick installation. When the blocks are installed, the hollow cells are filled with select granular fill<sup>1</sup> which then results in a heavier in-place block to resist soil forces.

The initial cost of the Murata™ retaining wall system is competitive with other wall systems and is significantly less than most conventional concrete walls. The lasting aesthetics and structural durability of the concrete Murata™ retaining wall system makes it a cost-effective solution when life-cycle costs are considered.

## INSTALLATION:

### 1. Wall Design Considerations

Before using Murata™ to build a wall, the following design considerations must be made (*Diagram A*):

- For a typical landscape wall the total wall height must not exceed 48" (1.2 m).
- If a toe slope is present, the bottom of the wall should not be above the finished grade at a distance of 48" (1.2 m) in front of the wall.
- The embedment height needs to be a minimum of 6" (152mm) below the ground surface.
- The length of the reinforcing geogrid needs to be a minimum of 48". Geogrid length is measured from the face of the wall.

### 2. Excavation and Preparing the Base

Check the location of existing structures and utilities before starting the excavation. Excavate the soil in the location where the retaining wall is to be constructed, assuring at least 48" of space on the rear side of the wall for gravel backfill<sup>1</sup>. Dig a trench for the leveling base that is at least 24" wide by 12" deep. Fill the trench with select granular fill<sup>1</sup> to a depth of 6" (150mm) and compact well with a plate compactor or jumping jack in 2" lifts, making sure that each layer is level. The plate compactor must weigh at least 250lbs. (*Diagram 1*) Install a minimum of a 4" perforated drain pipe in the rear of the excavation. Make sure that the drain pipe is sloped at a minimum 0.5% and empty to daylight at 50' maximum intervals, draining into a storm sewer or along a slope below the reinforced soil mass. Widen the excavation as required to maintain drain slope (*See diagram 1*).

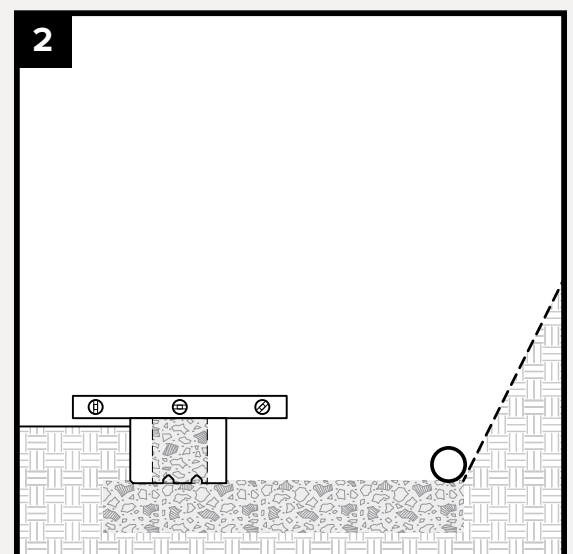
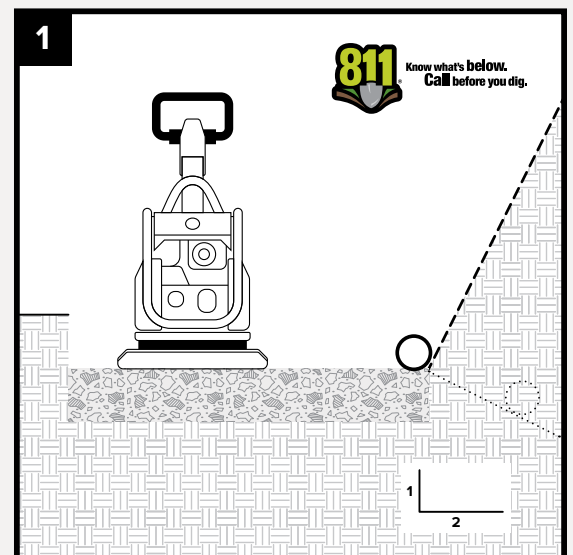
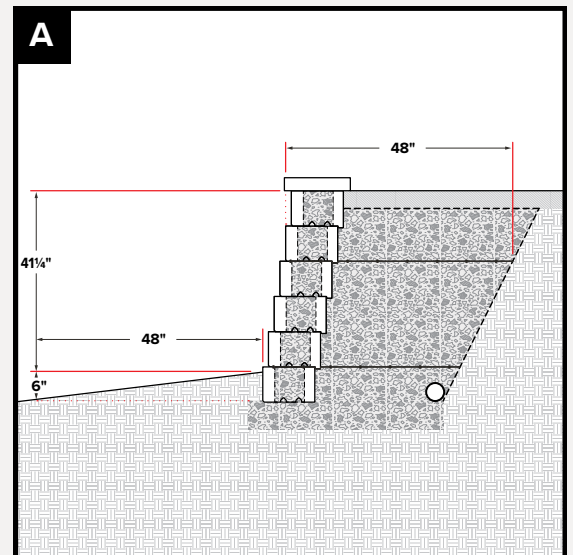

<sup>1</sup> Select granular fill must meet the ODOT ¾"-0 or ⅝"-0 WSDOT specification. More details available upon request.

### 3. Positioning the Bottom Course

Set the bottom course of block, utilizing the Murata™ Variable block, at the desired position on top of the prepared select granular fill<sup>1</sup> leveling base. Using a large rubber mallet and a level, adjust the block until it is level, end to end, front to back, and in full contact with the leveling base (*Diagram 2*). Set the adjacent blocks in the same manner, using a string line or a level to keep long runs straight and flat; ensuring that there is no space between adjacent blocks.

### 4. Backfilling and Geogrid

Place a layer of non-woven geotextile filter (TerraTex® N06 or equivalent) against the rear wall of the excavation, starting at the top of the leveling base and extending up to the top of the excavation. Do not install the geotextile filter below the structural foundation. Make sure that there is enough filter fabric to lay over the top of the backfill to keep topsoil from filtering down. Completely fill the block cavity and backfill with select granular fill<sup>1</sup> in maximum lifts of 4". Compact both thoroughly using lightweight compaction equipment that will not disrupt the stability or batter of the wall. Before setting the next course, cover the previous course of blocks and the backfill gravel with geogrid (StrataGrid® SG 350 or equivalent). Pay attention to the geogrid's reinforcement direction and make sure that it is perpendicular to the wall face. The minimum reinforcing length of the geogrid is 48" (*Diagram A*) and must be continuous. Splicing of the geogrid in the main reinforcing direction is not permitted. Follow geogrid manufacturer's guidelines for overlap requirements.

### 5. Subsequent Courses

Lay the next course of blocks and fill block cores with compacted select granular fill<sup>1</sup> to lock in place, making sure to wrap the geogrid slightly around the lip of the block (*Diagram 3*). A running bond pattern is the preferred method of block placement. The center of the current course should align with the seam between two blocks on the lower course. For optimum strength, maintain light tension on the geogrid by using stakes or pins. Place all the remaining courses backfilling the wall every 8" (one block height), and placing a reinforcing geogrid as outlined in Step 4 (*Diagram 4*).

### 6. Finishing the Wall

Set the top course and backfill to within 3" of the top. Fold the filter fabric (GF) over the top of the backfill. Finish backfill area with topsoil to the finished grade (*Diagram 5*). The top course or cap can either be held in place with an approved flexible adhesive (Flex-Bond SB20 or equivalent). Murata™ walls can be capped with the Murata™ MC4035 or MC8035 Cappello caps. Columns can be capped with either the MC6060 or MC7070 Cappello caps.

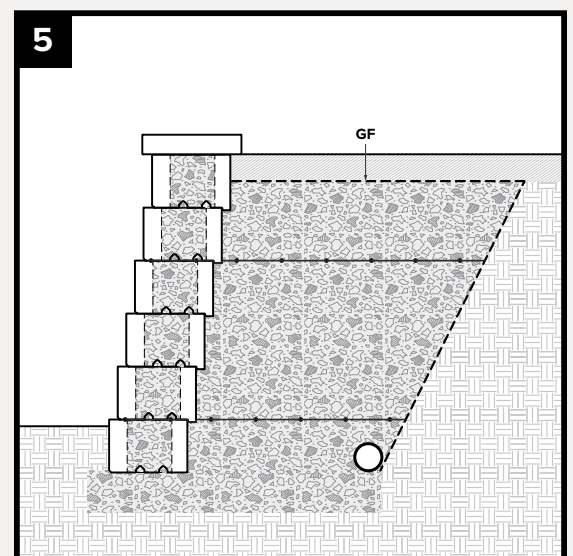
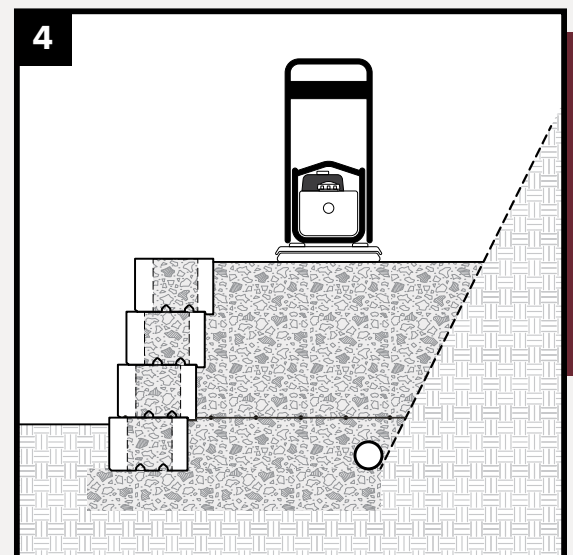
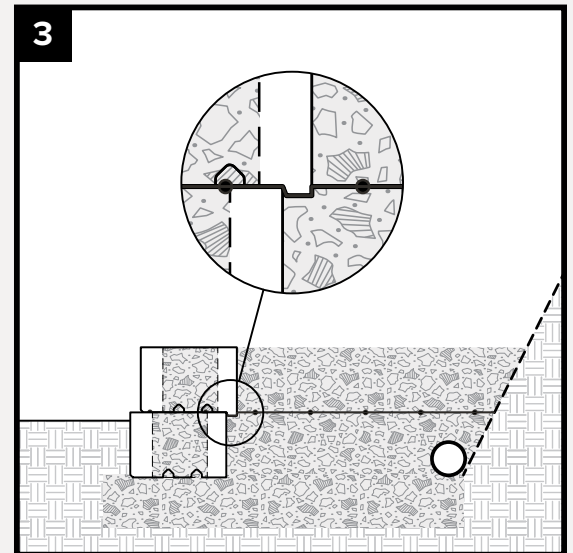



**Yes, you CAN  
do it yourself!**

**We'll show you how.**



Installing paving stones or retaining walls is not as difficult as you think. We've put together a series of articles and videos that are designed to equip you with the knowledge that you need to ensure that your project is a success.

To learn how you can DIY your hardscape project, visit:

**DIYwithWI.com**

ACCESSORIES

# Installation Accessories

We have a whole selection of paver installation accessories and materials. Some are shown below. If you are looking for something not included in here, please contact our sales office. There's a good chance we have it in stock or can get it for you.



**Snap-Edge®**



**Paver Hammer**



**Perma Paver Edging®**

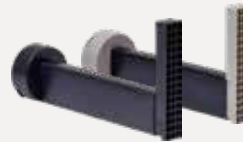

**Wall Drain Pro®**  
Black, Gray



**#1 Fine Sand**



**Dyna® Optimax Sand**  
Absolute Black,  
Granite Gray,  
Quartz Beige



**PolySweep Polymeric Sand**  
Tan, Gray



**PolySweep X-treme Wide Joint Polymeric Sand**  
Tan, Gray



**Alliance Gator Dust®**  
Sahara Beige, Stone Grey



**Alliance Gator Polymeric Sand & Dust Super Sand®**  
Sahara Beige, Slate Grey

# Sealers

Sealing is an essential step because, not only does it make your hardscape look beautiful, sealing makes it easier to maintain and will increase its life. We recommend a solvent-based sealer like SB-8700 for best results in our Pacific Northwest environment. For more details on applying sealer, visit:



[www.westerninterlock.com/how-to-seal-paving-stones](http://www.westerninterlock.com/how-to-seal-paving-stones)



Applying Sealer



**Gloss Finish Joint Stabilizing Sealer**  
SB-7000 Gloss Finish  
*(water based)*



**Antifungal Sealer**  
SB-7700 Satin Finish  
*(water based)*



**Wet Look Joint Stabilizing Sealer**  
SB-8700 Gloss Finish  
*(solvent based)*



**Wet Look Sealer**  
SB-9000 Gloss Finish  
*(solvent based)*

ACCESSORIES

# Efflorescence

Efflorescence is a whitish powder-like deposit, common on concrete and masonry products, that normally will disappear over time with weathering. Although it may present an aesthetic concern, efflorescence will not affect the structural performance of pavers or wall systems. With proper maintenance, efflorescence can be removed and the original color restored. Through manufacturing techniques, we attempt to reduce the likelihood of efflorescence. To learn how to remove efflorescence from pavers, visit:

[westerninterlock.com/how-to-remove-efflorescence](http://westerninterlock.com/how-to-remove-efflorescence)



# Fireplace Parts



**Rogue Chimney Cap**  
24"x28" Chimney insert size  
Covering size: 32"x36"  
Powdercoated steel



**Rogue Firebox Support**  
4x6x $\frac{3}{8}$ x30" angle iron  
Painted steel



**Deschutes Chimney Cap**  
12"x24" Chimney insert size  
Covering size: 26"x32"  
Powdercoated steel



**Deschutes Firebox Support**  
4x6x $\frac{3}{8}$ x27" angle iron  
Painted steel



**Firebrick**  
9x4.5x1.25"

# Paving Stone Specifications

Paving Stones	Pcs/ Layer	Layers/ Pallet	Pcs/ Pallet	Pcs/Sq Foot	Sq Ft/ Layer	Sq Ft/ Pallet	Lbs/pcs	Lbs/ Layer	Lbs/ Pallet
Alpine Stone Large Square (70mm)	9	8	72	.85	10.59	84.7	38	342	2714
Alpine Stone Large Rec (70mm)	12	8	96	1.28	9.36	74.88	26	312	2471
Alpine Stone Med Square (70mm)	20	8	160	1.92	10.4	83.2	20	400	2746
Alpine Stone Small Rec (70mm)	40	8	320	3.84	10.4	83.2	9	360	2746
Alpine Rotundo Stone (70mm)	12	4	48	n/a	11.4	45.6	varies	n/a	1425
Alpine Rotundo Single Stone (70mm)	12	8	96	1.04	11.5	92.3	30	356	2890
Arena Stone—Standard, Granite (60mm)	12	9	108	1	12	108	28	336	2970
Camino Stone Large Rec (60mm)	25	10	250	2.42	10.33	103	11	275	3067
Camino Stone Square (60mm)	35	10	350	3.65	9.6	97	8	280	2888
Camino Stone Small Rec (60mm)	49	9	441	4.76	10.3	92.6	6	294	2515
City Square (60mm)	42	9	378	4.09	10.22	92.42	8	336	3024
Double Park	12	9	108	1.15	10.44	93.9	23	276	2593
Granite - 5 Stone (60 mm)	25	10	250	n/a	9.6	96	varies	292	2920
Holland Stone—Standard, Roca, Granite (60mm)	48	9	432	4.56	10.5	94.7	6	289	2605
Half Holland Stone—Standard, Roca, Granite (60mm)	88	5	440	9.12	9.77	48.8	3	264	1360
La Lastra Large Square (50mm)	2	9	18	.25	8	72	94	188	1700
La Lastra Medium Square (50mm)	4	9	36	.45	9	81	54	216	1910
La Lastra Large Rectangle (50mm)	4	9	36	.34	12	108	71	360	3240
La Pietra Grande (60mm)	2	8	16	.33	6	48	84	168	1344
La Pietra Large Rectangle (60mm)	4	8	32	.5	8	64	56.7	227	1816
La Pietra Medium Square (60mm)	6	8	48	.75	8	64	38	228	1824
La Pietra Small Rectangle (60mm)	12	8	96	1.52	7.9	63.2	19	228	1824
La Pietra Small Square (60mm)	24	8	192	2.9	8.28	66.24	9.5	228	1824
La Pietra Moderna Grande (60mm)	2	10	20	.33	6.	60.6	84	168	1680

SPECIFICATIONS

# Paving Stone Specifications

Paving Stones	Pcs/ Layer	Layers/ Pallet	Pcs/ Pallet	Pcs/Sq Foot	Sq Ft/ Layer	Sq Ft/ Pallet	Lbs/pcs	Lbs/ Layer	Lbs/ Pallet
La Pietra Moderna Large Rectangle (60mm)	4	10	40	.5	8	80	56.5	226	2260
La Pietra Moderna Medium Square (60mm)	6	10	60	.75	8	80	38	228	2280
La Pietra Moderna Small Rectangle (60mm)	12	10	120	1.52	7.9	79	19	228	2280
La Pietra Moderna Small Square (60mm)	24	10	240	2.9	8.3	82.8	9.5	228	2280
Leiden - 5 Stone (60mm)	25	10	250	n/a	9.6	96	varies	292	2920
Park Stone—Standard, Cobble, Roca, Granite (60mm)	24	9	216	2.29	10.5	94.1	12	288	2588
Plaza Stone—Standard, Cobble, Roca, Granite (60mm)	18	8	144	1.53	11.76	94.1	18	324	2588
Roma Stone	40	9	360	varies	10.2	91.8	varies	242	2160
Rotundo Stone (60mm)	37	9	333	n/a	11.5	103.5	varies	316	2850
Cobble Slimline Large Rec (40mm)	30	9	270	3.24	9.26	83.3	6	180	1660
Cobble Slimline Square (40mm)	48	12	576	4.88	9.84	118	4	192	2143
Holland Slimline (40mm)	45	12	540	4.51	9.98	119.7	4	180	2127
Villa Stone (100mm)	28	5	140	2.86	9.8	49	16	448	2280
Permeable Pavers	Pcs/ Layer	Layers/ Pallet	Pcs/ Pallet	Pcs/Sq Foot	Sq Ft/ Layer	Sq Ft/ Pallet	Lbs/pcs	Lbs/ Layer	Lbs/ Pallet
Permeare Camino Square (60mm)	42	9	378	3.65	11.5	103.6	7.3	306	2770
Permeare Camino Rec (60mm)	30	9	270	2.42	12.4	111.5	10.9	327	2960
Permeare Holland Stone (60mm)	54	9	486	4.56	11.85	106.6	5.6	302	2750
Permeare Park Stone (60mm)	24	9	216	2.29	10.5	94.3	12.4	298	2687
Turf Stone (100mm)	4	5	20	.38	10.4	52	73	292	1456
VS-5™ Drain Pave (88mm)	20	6	120	2.35	8.5	52	16	320	1920
Non-stock Products	Pcs/ Layer	Layers/ Pallet	Pcs/ Pallet	Pcs/Sq Foot	Sq Ft/ Layer	Sq Ft/ Pallet	Lbs/pcs	Lbs/ Layer	Lbs/ Pallet
Holland (80mm)	54	7	378	4.5	12.1	85	8.22	444	3145
Symmetry Stone (60mm)	32	9	288	3.5	9.1	82	8	256	2255
Holland Permeare 90° Herringbone (80mm)	36 whole 8 half	7	252 whole 56 half	4.56	8.6	60.2	8.22	351	2107

# Retaining Wall Specifications

Wall Blocks	Pcs/ Layer	Layers/ Pallet	Pcs/ Pallet	Pcs/Sq Foot	Sq Ft/ Layer	Sq Ft/ Pallet	Lbs/pcs	Lbs/ Layer	Lbs/ Pallet
Chateau Wall™ (100mm)	60	5	300	9.3	6.45	32.24	9.5	570	2850
Chateau Wall™ (200mm)	30	5	150	4.66	6.45	32.24	19	570	2850
Chateau Wall™ (300mm)	20	5	100	3.1	6.45	32.24	28.5	570	2850
Chateau Wall™ (400mm)	15	5	75	2.33	6.45	32.24	38	570	2850
Chateau Wall™ Beveled	36	5	180	4.66	6	30	16	448	2260
Chateau Diviso™ (200mm)	30	5	150	4.66	6.45	32.24	19	570	2850
Chateau Diviso™ (300mm)	20	5	100	3.1	6.45	32.24	28.5	570	2850
Chateau Diviso™ (400mm)	15	5	75	2.33	6.45	32.24	38	570	2850
Chateau Diviso™ Beveled	16	5	80	3.1	5.16	30	16	448	2260
Chateau Moderna™ (200mm)	48	3	144	4.66	10.30	30.9	19	912	2736
Chateau Moderna™ (300mm)	32	3	96	3.1	10.30	30.9	28.5	912	2736
Chateau Moderna™ (400mm)	24	3	72	2.33	10.30	30.9	38	912	2736
Chateau Moderna™ Beveled	28	3	140	4.66	6	30	16	448	2260
Gradino Step Block	8	5	40	1.5	15	40	88	880	3520
Jumbo Nursery	9	6	54	1.5	6	36	57	513	3078
Jumbo Nursery Straight Face	9	6	54	1.5	6	36	65	585	3510
Jumbo Step Block	10	5	50	.75	7.5	37.5	90	67.5	4500
Nursery Stone	16	6	96	3	5.33	32	18	288	1750
Murata™ MS4020 Standard	8	5	40	1.15	7	35	60.65	69.75	2426
Murata™ MV4020 Variable	8	5	40	1.15	7	35	60	69.75	2400
Murata™ MA4020 Angolo	6 sets 12 pieces	5	30 sets 60 pieces	1.15	10.4	52	47	54.65	2820
Slope Block	12	4	48	2.08	5.78	23.1	60	124.8	2880
Tegula/Tegula Beveled	30	3	90	2.35	12.77	38.3	33	990	2970

SPECIFICATIONS



Cap Stones				Pcs/Linear Foot	Linear Foot/ Layer	Linear Foot/ Pallet		Lbs/Linear Foot	
Chateau Diviso™ Cap	12	7	84	1.2	n/a	n/a	26	312	2184
Chateau Diviso™ Column Cap	2	5	10	n/a	n/a	n/a	130	260	1300
Jumbo Cap Stone	9	8	72	.77	7.5	55	40	30.8	2880
Nursery Cap Stone	16	6	96	1.09	17.44	88	21	22.9	2000
Murata™ MC4035 Cappello	6	5	30	.76	7.88	39.4	52.5	39.9	1584
Murata™ MC8035 Cappello	3	5	15	.38	7.88	39.37	105	40	1560
Murata™ MC6060 Cappello	2	5	10	n/a	n/a	n/a	136	n/a	1360
Murata™ MC7070 Cappello	1	5	5	n/a	n/a	n/a	180	n/a	900
Monaco™ Coping	40	4	160	2.03	20.3	81.2	13	26.39	2120
Versa-Cap™	6	8	48	.67	4	32	47	32	2300

## Project Credits

Thank you to all the contractors who installed our products in the past year. Here's a list of who installed what:

**AG Landscape LLC:** pages 23, 25; **Aguiar Pavers:** pages 23, 55; **All Seasons Contracting:** pages 48, 66, 77, 85; **Archiscape:** pages 41, 49;  
**Arellano Pavers:** pages 16, 17, 31, 42, 45, 74; **Banyan Tree Landscape Construction:** page 25; **Cascadia Landscape:** page 33;  
**Eagle Landscape Services:** page 18; **Eli's Paver Patios:** pages 7, 39, 77; **Endless Designs:** pages 25, 35;  
**Forest Landscape, Inc.:** pages 4, 7, 30, 41, 43, 47, 51, 56, 57, 61, 62, 72, 73, 75, 76, 77; **FRC Construction:** pages 10, 19, 57; **Green Acres Landscape:** page 58;  
**Hilltop Construction:** page 70; **Merten & Sons:** pages 15, 73; **Neathery Landscape:** cover & pages 4, 6, 39, 67, 75; **New Era Landscape:** page 25;  
**NW Evergreen Landscape:** pages 41, 65; **NW Pro Landscapes:** pages 13, 60, 74; **Oregon General Hardscape:** page 53;  
**Oregon Landscape Co.:** pages 22, 27; **Pacific Pavers:** pages 51, 71, 75, 77; **Paver Creations:** page 23; **Pavers N Stones:** pages 38, 76;  
**Pride Hardscape:** pages 4, 15, 29, 44, 50, 61, 64, 72, 73, 75, 85; **Quality Paving & Design:** pages 11, 51; **RG Pavers:** pages 17, 63;  
**Ring Paver Construction:** page 72; **Sequoia Stonescapes:** pages 7, 20, 21, 24, 26, 31, 35, 47, 61, 66, 74, 85;  
**Sta-built Construction:** pages 34, 47, 49, 54, 55, 67; **Stone Paving, Inc.:** page 31; **Stone Solid Installation:** page 14;  
**Terrace Hardscapes:** page 49; **Three Sisters Hardscape:** page 5; **True Valley Landscape:** page 7;  
**Vulcan Design & Construction:** pages 13, 15, 32, 35, 36, 37, 39, 40, 49, 65, 66, 73, 76; **Western Paver Design:** page 13;  
**Westover Works:** pages 8, 9, 63, 64, 68; **Zuzul Landscape LLC:** page 53;  
**Western Interlock Marketing Crew:** pages 8, 17, 21, 23, 51, 59, 64, 68, 69, 74, 76, 100



Want to see photos of your jobs in next year's brochure?

Send high resolution photos to us at [westerninterlockmarketing@gmail.com](mailto:westerninterlockmarketing@gmail.com)

SEND EMAIL

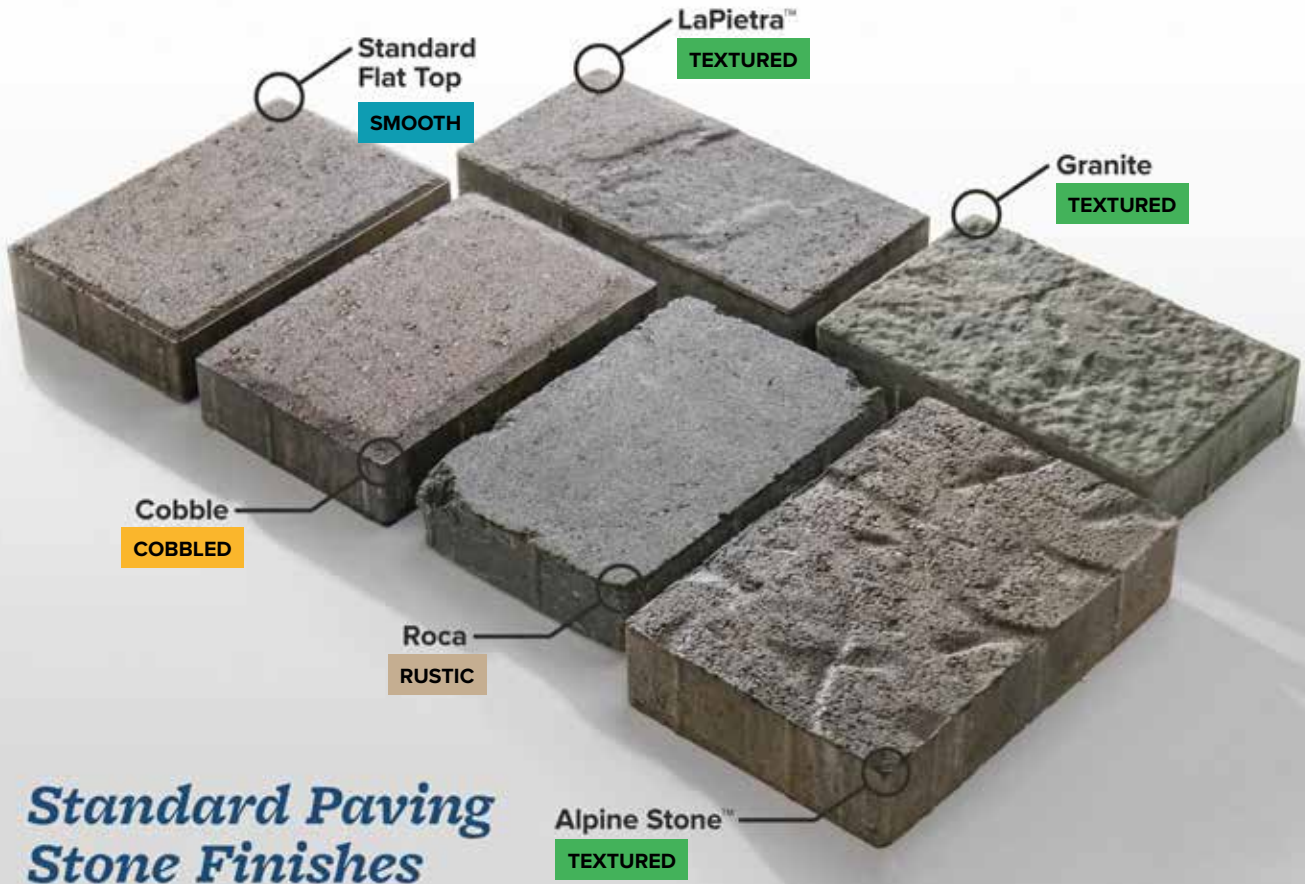

## Standard Paving Stone Finishes

*(Not all finishes available in all stones)*

Suitable for pedestrian traffic only  
Available in Slimline Holland and Slimline Cobble

40mm

Suitable for pedestrian traffic only  
Available in LaLastra™

50mm

Suitable for pedestrian and light vehicular traffic  
Available in all standard paving stones

60mm

Suitable for pedestrian and heavy vehicular traffic  
Available in Alpine Stone™

70mm

Suitable for pedestrian and heavy vehicular traffic  
Available on select stones by special order.

80mm



## Standard Paving Stone Thicknesses

*(Not all thicknesses available in all stones)*





*We invite you to stop by any of our retail facilities or dealerships to speak with a knowledgeable sales person, and to see our product in person.*

**WESTERN INTERLOCK RETAIL FACILITIES:**

10095 Rickreall Rd, Rickreall, OR 97371

9145 Fassett St., Olympia, WA 98512



*Paving Stones & Retaining Wall Systems Made for the Northwest.*

**503.623.9084** OR  
**360.878.9301** WA

**westerninterlock.com**